

HILTI



Hilti HIT-RE 500-SD

Instructions for use	en
Instrucciones de uso	es
Mode d'emploi	fr
Instruções de utilização	pt



Danger























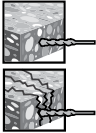
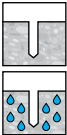





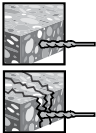

Contains epoxy constituents. May produce an allergic reaction.(A)



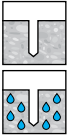











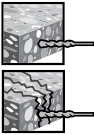

Contains: reaction product: bisphenol-A-(epichlorhydrin) epoxy resin MW \leq 700 (A), reaction product: bisphenol-F epichlorhydrin resin MW \leq 700 (A), m-Xylenediamine.(B)

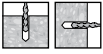
Causes severe skin burns and eye damage.(B)
May cause an allergic skin reaction.(A,B)
Toxic to aquatic life with long lasting effects.(A)

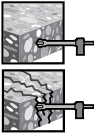
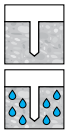
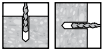

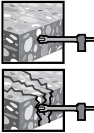
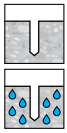
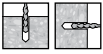
en	Adhesive anchoring system for rebar and anchor fastenings in concrete. Read the safety instructions, general informations and warnings before using the product.	→ 
es	Resina de inyección para la fijación de anclajes y tacos en hormigón. Lea las indicaciones de seguridad, la información general y las advertencias antes de utilizar el producto.	→ 
fr	Mortier de scellement pour ancrage de chevilles et d'armatures dans le béton. Avant utilisation, bien lire les prescriptions de sécurité, les informations générales et les indications d'avertissement.	→ 
pt	Buchas químicas para fixações de ferros e de ancoragens em betão. Antes da aplicação, ler a ficha de segurança, as informações gerais e as advertências.	→ 

						
1			$7/16'' \dots 1 1/2''$ 10...40 mm	$2 3/8'' \dots 10''$ 60...250 mm		
2			$7/16'' \dots 1 1/2''$ 10...40 mm	$2 3/8'' \dots 75''$ 60...1920 mm		
3						
4			$7/16'' \dots 1 1/2''$ 10...40 mm	$2 3/8'' \dots 10''$ 60...250 mm		
5			$7/16'' \dots 1 1/2''$ 10...40 mm	$2 3/8'' \dots 75''$ 60...1920 mm		
6			$7/16'' \dots 1 1/2''$ 10...40 mm	$2 3/8'' \dots 10''$ 60...250 mm		
7			$7/16'' \dots 1 1/2''$ 10...40 mm	$2 3/8'' \dots 75''$ 60...1920 mm		
8						

						
9			$\frac{7}{16}'' \dots 1 \frac{1}{2}''$ 10...40 mm	$2 \frac{3}{8}'' \dots 75''$ 60...1920 mm		
10			$\frac{1}{2}'' \dots 1 \frac{1}{8}''$ 12...32 mm	$2 \frac{3}{8}'' \dots 10''$ 60...250 mm		
11			$\frac{1}{2}'' \dots 1 \frac{1}{8}''$ 12...32 mm	$2 \frac{3}{8}'' \dots 39 \frac{3}{8}''$ 60...1000 mm		
12						



en	Dry concrete	Water saturated concrete	Waterfilled borehole in concrete	Submerged borehole in concrete
es	Hormigón seco	Hormigón saturado de agua	Taladro lleno de agua en hormigón	Taladro sumergido en hormigón
fr	Béton sec	Béton saturé d'eau	Trou dans le béton rempli d'eau	Trou dans le béton immergé
pt	Betão seco	Betão saturado de água	Furo em betão cheio de água	Furo debaixo de água em betão



en	Threaded rod Threaded sleeve	Rebar	Uncracked concrete	Cracked concrete
es	Tige fileté Douille fileté	Armature métallique	Béton non lézardé	Béton lézardé
fr	Varilla roscada Manguito roscado	Barras corrugadas para armado	Hormigón no fisurado	Hormigón fisurado
pt	Barra roscada Casquilho roscado	Ferros de armadura	Betão não fissurado	Betão fissurado



en Hammer drilling

Diamond coring

Hollow drill bit

es Taladrado con martillo

Taladrado con diamante

Taladro con broca hueca y aspiración

fr Perçage avec percussion

Forage au diamant

Foret creux

pt Perfurar de martelo

Perfurar com equipamento diamantado

Broca de coroa oca



t_{work}



$t_{cure, ini}$



$t_{cure, full}$

en Working time

Initial curing time

Curing time

es Tiempo de tratamiento

Resistencia de montaje

Tiempo de fraguado

fr Temps de manipulation

Stabilité du montage

Temps de durcissement

pt Tempo de trabalho

Resistência de montagem

Tempo de cura total

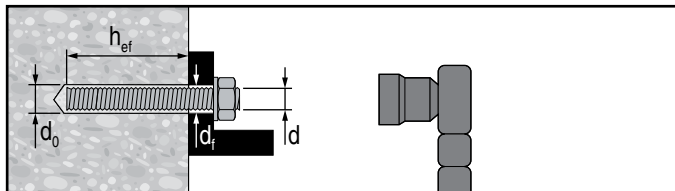
HIT-V (-R, -F, -HCR) / HAS-E (-B7) / HAS-R

HAS / HIT-V

 $\emptyset d$ [inch]	$\emptyset d_0$ [inch]	h_{ef} [inch]	$\emptyset d_f$ [inch]	T_{max} [ft-lb]	T_{max} [Nm]
3/8	7/16	2 3/8 ... 7 1/2	7/16	15	20
1/2	9/16	2 3/4 ... 10	9/16	30	41
5/8	3/4	3 1/8 ... 12 1/2	11/16	60	81
3/4	7/8	3 1/2 ... 15	13/16	100	136
7/8	1	3 1/2 ... 17 1/2	15/16	125	169
1	1 1/8	4 ... 20	1 1/8	150	203
1 1/4	1 3/8	5 ... 25	1 3/8	200	271

HIT-V

 $\emptyset d$ [mm]	$\emptyset d_0$ [mm]	h_{ef} [mm]	$\emptyset d_f$ [mm]	T_{max} [Nm]
M8	10	60...160	9	10
M10	12	60...200	12	20
M12	14	70...240	14	40
M16	18	80...320	18	80
M20	22	90...400	22	150
M24	28	96...480	26	200
M27	30	108...540	30	270
M30	35	120...600	33	300

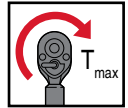
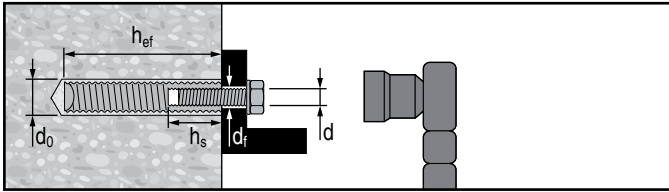
1 inch = 25,4 mm

HIS (-N, -RN)

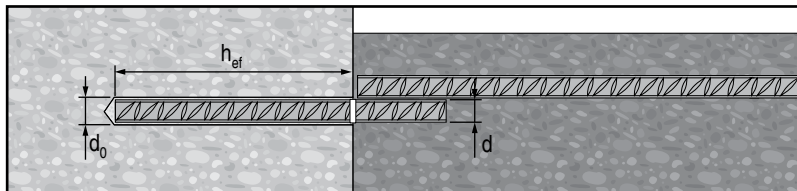

 $\varnothing d$ [inch]	$\varnothing d_0$ [inch]	h_{ef} [inch]	$\varnothing d_f$ [inch]	h_s [inch]	T_{max} [ft-lb]	T_{max} [Nm]
$\frac{3}{8}$	$1\frac{1}{16}$	$4\frac{3}{8}$	$\frac{7}{16}$	$\frac{3}{8} \dots \frac{15}{16}$	15	20
$\frac{1}{2}$	$\frac{7}{8}$	5	$\frac{9}{16}$	$\frac{1}{2} \dots 1\frac{3}{16}$	30	41
$\frac{5}{8}$	$1\frac{1}{8}$	$6\frac{3}{4}$	$\frac{11}{16}$	$\frac{5}{8} \dots 1\frac{1}{2}$	60	81
$\frac{3}{4}$	$1\frac{1}{4}$	$8\frac{1}{8}$	$\frac{13}{16}$	$\frac{3}{4} \dots 1\frac{7}{8}$	100	136

 $\varnothing d$ [mm]	$\varnothing d_0$ [mm]	h_{ef} [mm]	$\varnothing d_f$ [mm]	h_s [mm]	T_{max} [Nm]
M8	14	90	9	8...20	10
M10	18	110	12	10...25	20
M12	22	125	14	12...30	40
M16	28	170	18	16...40	80
M20	32	205	22	20...50	150

Rebar

US Rebar

	$\varnothing d_0$ [inch]	h_{ef} [inch]
d		
#3	$\frac{1}{2}$	$2\frac{3}{8} \dots 22\frac{1}{2}$
#4	$\frac{5}{8}$	$2\frac{3}{4} \dots 30$
#5	$\frac{3}{4}$	$3\frac{1}{8} \dots 37\frac{1}{2}$
#6	$\frac{7}{8}$	$3\frac{1}{2} \dots 15$
	1	15...45
#7	1	$3\frac{1}{2} \dots 17\frac{1}{2}$
	$1\frac{1}{8}$	$17\frac{1}{2} \dots 52\frac{1}{2}$
#8	$1\frac{1}{8}$	4...20
	$1\frac{1}{4}$	20...60
#9	$1\frac{3}{8}$	$4\frac{1}{2} \dots 67\frac{1}{2}$
#10	$1\frac{1}{2}$	5...75

CA Rebar

	$\varnothing d_0$ [inch]	h_{ef} [mm]
d		
10 M	$\frac{9}{16}$	70...678
15 M	$\frac{3}{4}$	80...960
20 M	1	90...1170
25 M	$1\frac{1}{4}$ (32 mm)	101...1512
30 M	$1\frac{1}{2}$	120...1794

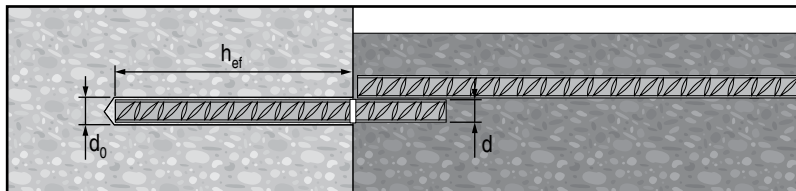

1 inch = 25,4 mm

Rebar





EU Rebar



 $\varnothing d$ [mm]	$\varnothing d_0$ [mm]	h_{ef} [mm]
8	12	60...480
10	14	60...600
12	16	70...720
14	18	75...840
16	20	80...960
18	22	85...1080
20	25	90...1200
22	28	95...1320
24	32	96...1440
25	32	100...1500
26	35	104...1560
28	35	112...1680
30	37	120...1800
32	40	128...1920

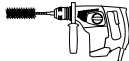

	HAS	HIS-N	Rebar			HIT-DL	HIT-OHC
d_0 [inch]	d [inch]			[inch]	[inch]	[inch]	Art. No.
7/16	3/8	-	-	7/16	-	-	387551
1/2	-	-	#3	1/2	1/2	1/2	
9/16	1/2	-	10M	9/16	9/16	9/16	
5/8	-	-	#4	5/8	5/8	9/16	
11/16	-	3/8	-	11/16	11/16	11/16	
3/4	5/8	-	15M #5	3/4	3/4	3/4	
7/8	3/4	1/2	#6	7/8	7/8	7/8	387552
1	7/8	-	20M #6 #7	1	1	1	
1 1/8	1	5/8	#7 #8	1 1/8	1 1/8	1	
1 1/4	-	3/4	25M #8	1 1/4	1 1/4	1	
1 3/8	1 1/4	-	#9	1 3/8	1 3/8	1 3/8	
1 1/2	-	-	30M #10	1 1/2	1 1/2	1 3/8	

HIT-DL: $h_{ef} > 10''$

HIT-RB: $h_{ef} > 20 \times d$ 

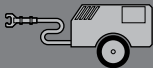



	HIT-RE-M		HIT-OHW
	Art. No.		Art. No.
Hilti VC	337111	HDM 330 HDM 500 HDE 500-A18	387550



			
d_0 [inch]	[inch]	Art. No. 381215	
7/16" ... 1 1/8"	2 3/8" ... 52 1/2"	✓	≥ 6 bar/90 psi @ 6 m³/h
1 1/4" ... 1 1/2"	4" ... 75"	-	≥ 140 m³/h / ≥ 82 CFM





	HIT-V	HIS-N	Rebar			HIT-DL	HIT-OHC
d_o [mm]	d [mm]			[mm]	[mm]		Art. No.
10	8	-	-	10	-	-	387551
12	10	-	8	12	12	12	
14	12	8	10	14	14	14	
16	-	-	12	16	16	16	
18	16	10	14	18	18	18	
20	-	-	16	20	20	20	
22	20	12	18	22	22	20	
25	-	-	20	25	25	25	
28	24	16	22	28	28	25	387552
30	27	-	-	30	30	25	
32	-	20	24/25	32	32	32	
35	30	-	26/28	35	35	32	
37	-	-	30	37	37	32	
40	-	-	32	40	40	32	

 HIT-DL: $h_{ef} > 250$ mm

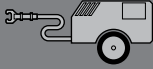



 HIT-RB: $h_{ef} > 20 \times d$

	HIT-RE-M		HIT-OHW
			
	Art. No.		Art. No.
Hilti VC	337111	HDM 330 / 500 HDE 500-A18	387550





			
d_o [mm]	[mm]	Art. No. 381215	
10...32	60...1500	✓	≥ 6 bar/90 psi
35...40	100...1920	-	≥ 140 m ³ /h

			 t_{work}	 $t_{\text{cure, ini}}$	 $t_{\text{cure, full}}$
	[°C]	[°F]			
	5	41	2 ½ h	≥ 18 h	≥ 72 h
	10	50	2 h	≥ 12 h	≥ 48 h
	15	59	1 ½ h	≥ 8 h	≥ 24 h
	20	68	30 min	≥ 6 h	≥ 12 h
	30	86	20 min	≥ 4 h	≥ 8 h
	40	104	12 min	≥ 2 h	≥ 4 h



Rebar - $h_{ef} \geq 20d$

		h_{ef}		
HDM, HDE, HIT-P 8000D	\leq US #5	12 1/2 ... 37 1/2 [inch]	41 °F ... 104 °F 5 °C ... 40 °C	41 °F ... 104 °F 5 °C ... 40 °C
	\leq EU 16mm	320 ... 960 [mm]		
	\leq CAN 15M	320 ... 960 [mm]		
HDE, HIT-P 8000D	\leq US #7	17 1/2 ... 52 1/2 [inch]	41 °F ... 104 °F 5 °C ... 40 °C	41 °F ... 104 °F 5 °C ... 40 °C
	\leq EU 20mm	400 ... 1200 [mm]		
	\leq CAN 20M	390 ... 1170 [mm]		
HIT-P 8000D	\leq US #10	25 ... 75 [inch]	41 °F ... 104 °F 5 °C ... 40 °C	41 °F ... 104 °F 5 °C ... 40 °C
	\leq EU 32mm	640 ... 1920 [mm]		
	\leq CAN 30M	598 ... 1794 [mm]		

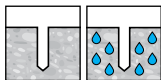
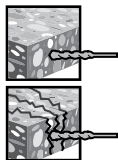

		h_{ef}		
HDM, HDE, HIT-P 8000D	\leq US #5	12 1/2 ... 37 1/2 [inch]	41 °F ... 104 °F 5 °C ... 40 °C	41 °F ... 104 °F 5 °C ... 40 °C
	\leq EU 16mm	320 ... 960 [mm]		
	\leq CAN 15M	320 ... 960 [mm]		
HDE, HIT-P 8000D	\leq US #7	17 1/2 ... 39 3/8 [inch]	41 °F ... 104 °F 5 °C ... 40 °C	41 °F ... 104 °F 5 °C ... 40 °C
	\leq EU 20mm	400 ... 1000 [mm]		
	\leq CAN 20M	390 ... 1000 [mm]		

1



d_0 :
 $7/16'' \dots 1 1/2''$
 10...40 mm

h_{ef} :
 $2 3/8'' \dots 10''$
 60...250 mm

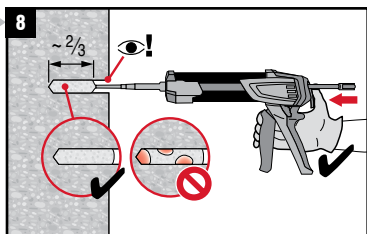
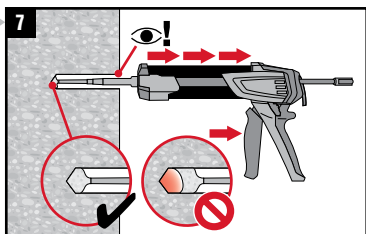
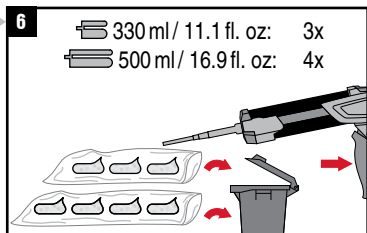
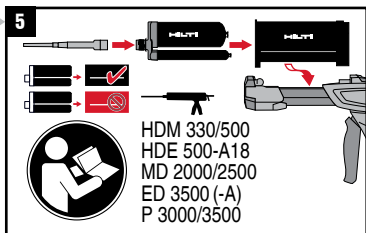
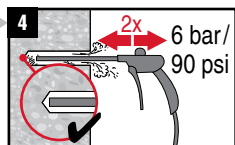
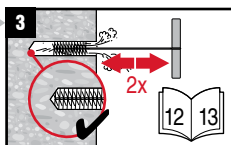
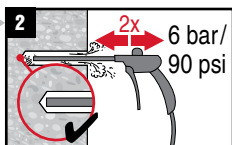
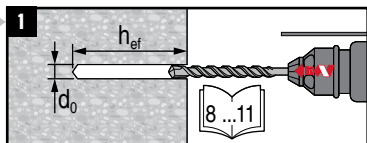
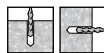

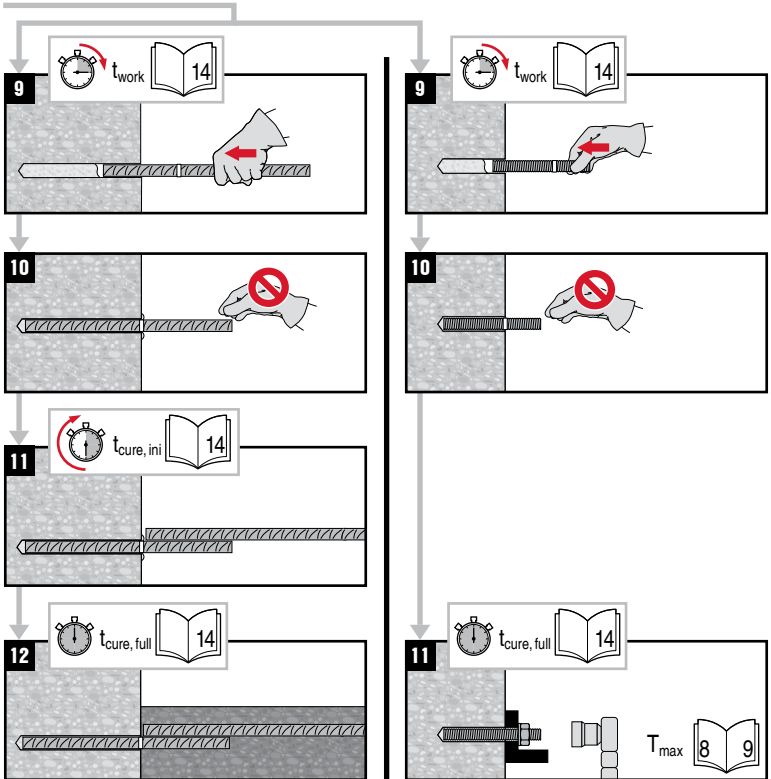

2

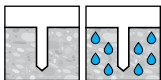
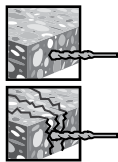

d_0 :
7/16" ... 1 1/2"
10...40 mm

h_{ef} :
2 3/8" ... 75"
60...1920 mm

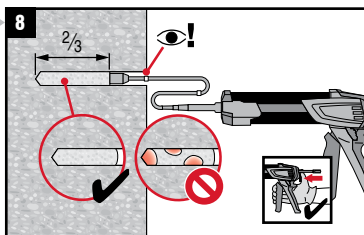
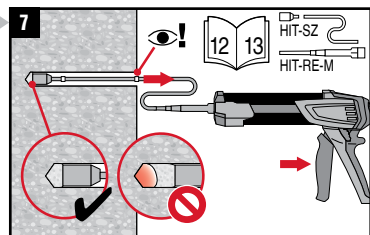
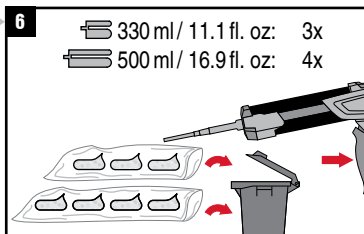
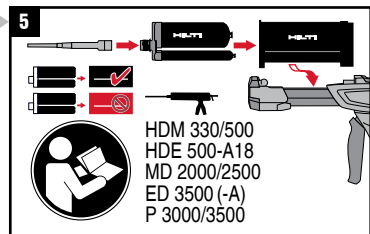
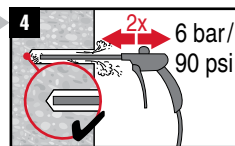
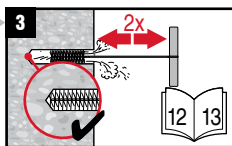
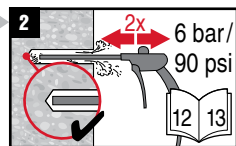
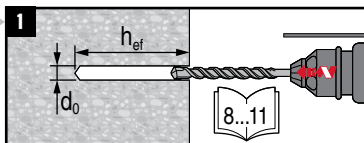
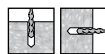

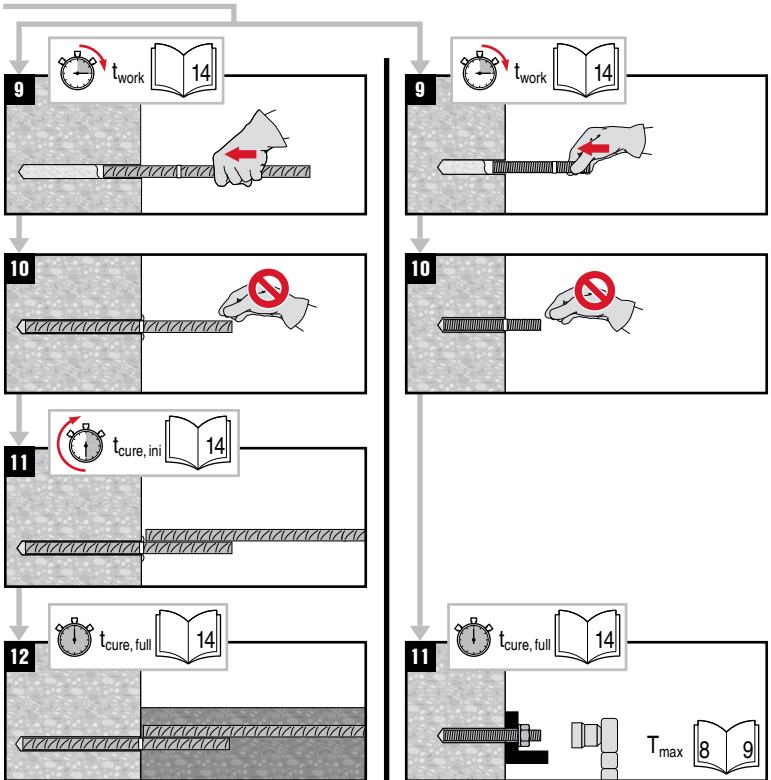

3

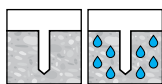
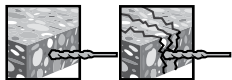

d_0 :
 $7/16'' \dots 1 1/2''$
 $10 \dots 40 \text{ mm}$

h_{ef} :
 $2 3/8'' \dots 75''$
 $60 \dots 1920 \text{ mm}$

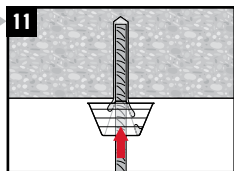
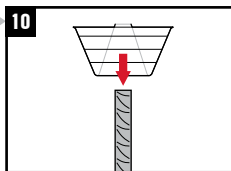
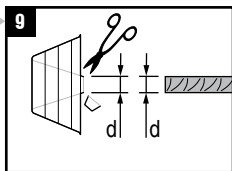
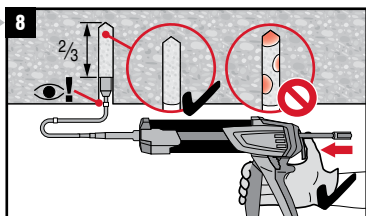
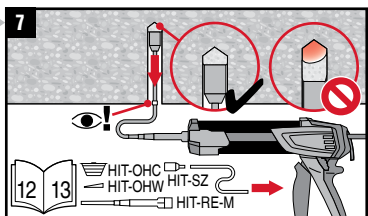
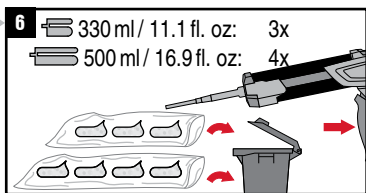
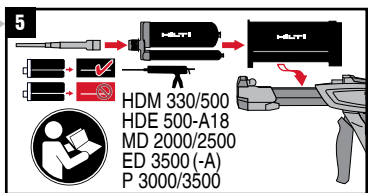
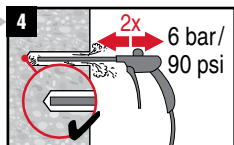
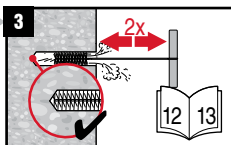
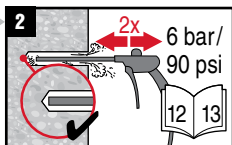
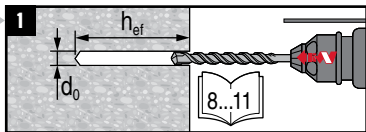

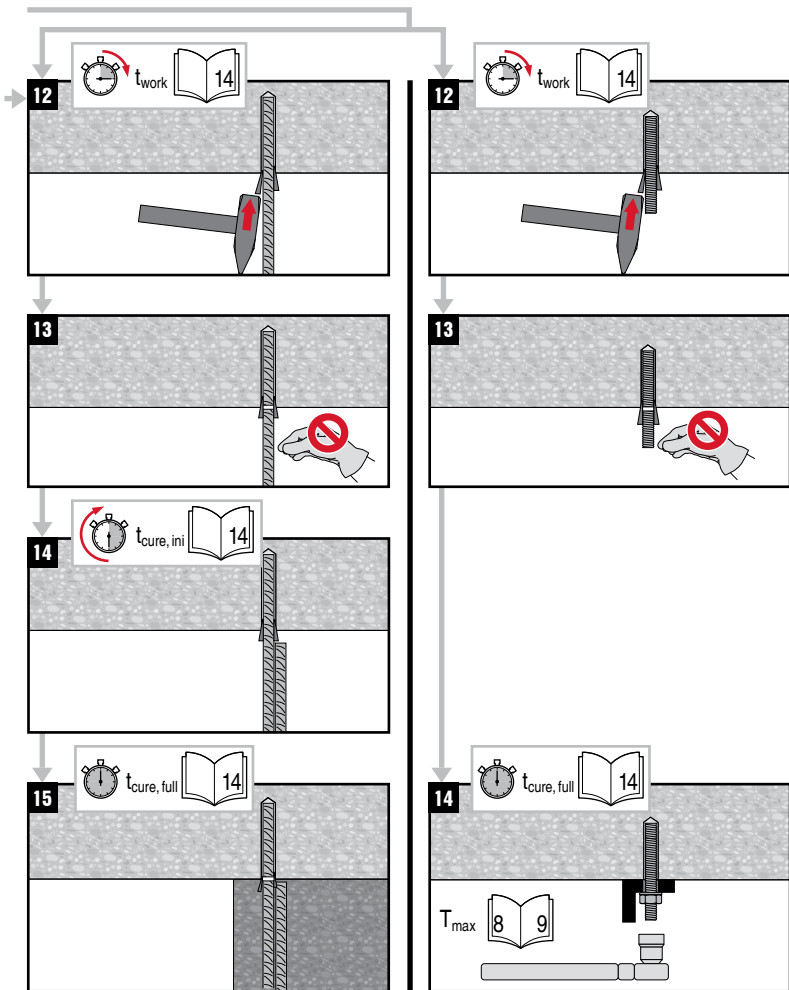

4

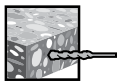

d_0 :
 $7/16'' \dots 1 1/2''$
 10...40 mm

h_{ef} :
 $2 3/8'' \dots 10''$
 60...250 mm

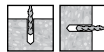

6

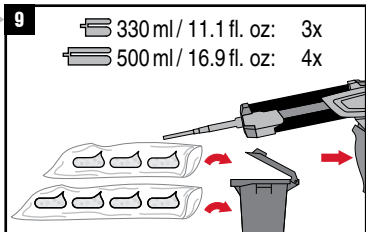
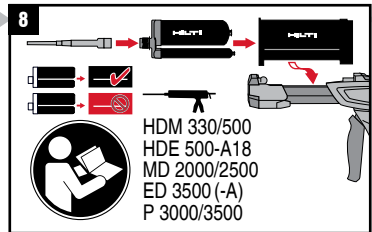
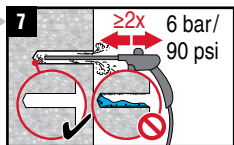
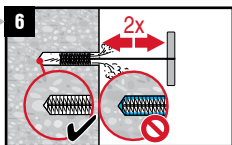
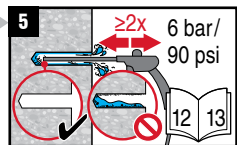
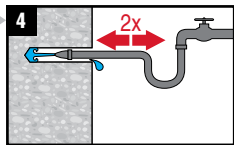
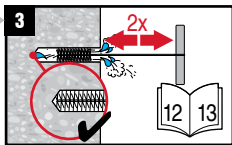
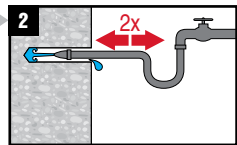
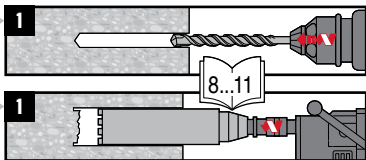
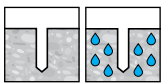
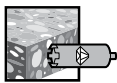

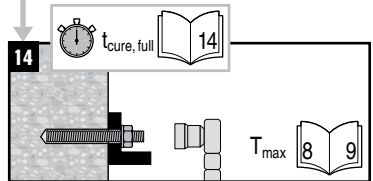
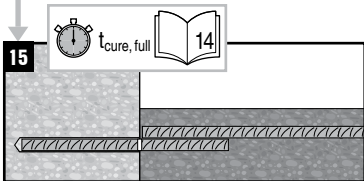
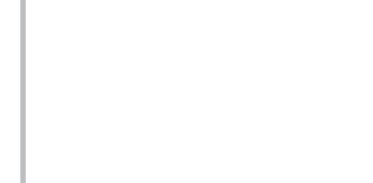
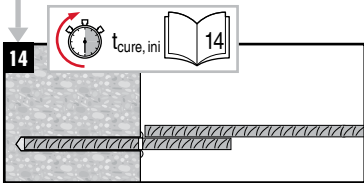
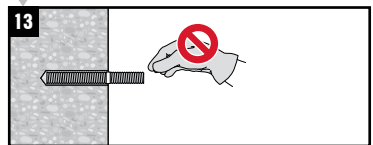
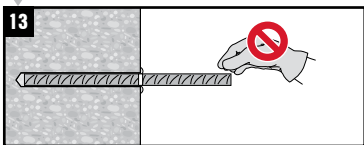
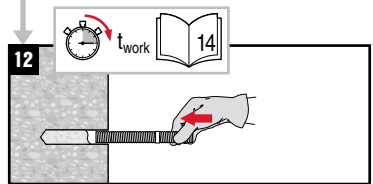
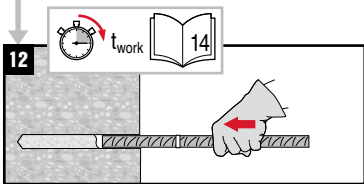
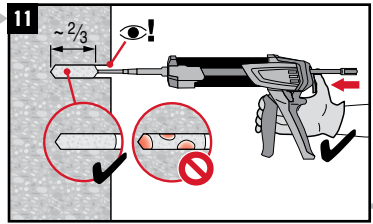
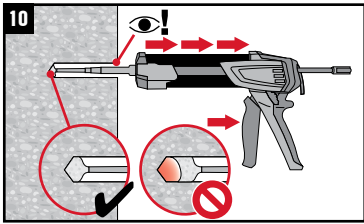

5

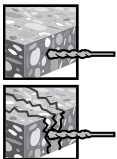

d_0 :
 $\frac{7}{16}$ "... $1\frac{1}{2}$ "
 10...40 mm

h_{ef} :
 $2\frac{3}{8}$ "...75"
 60...1920 mm



7

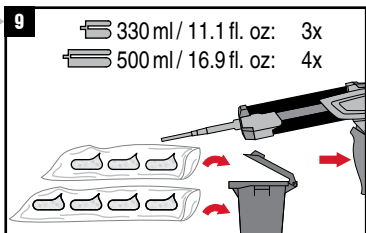
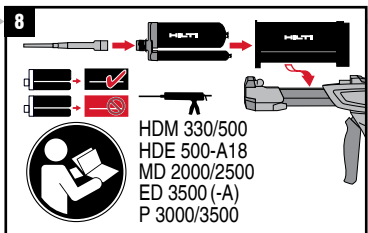
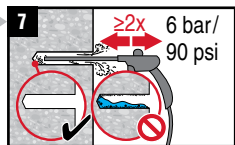
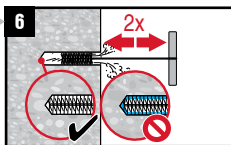
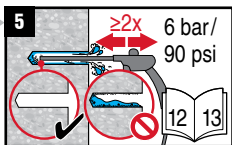
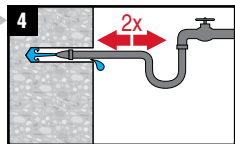
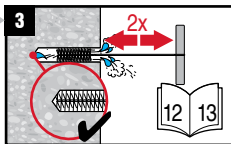
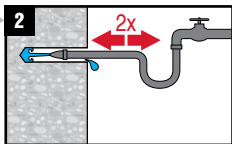
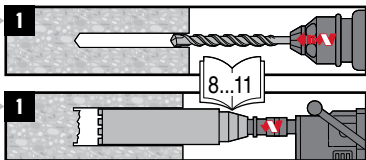
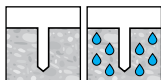
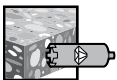

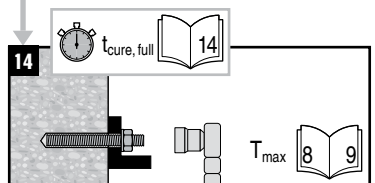
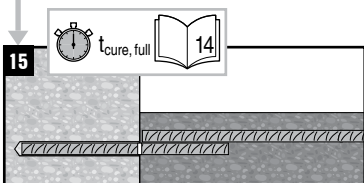
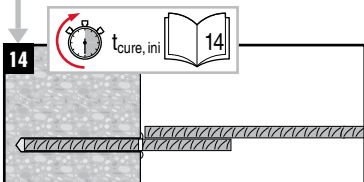
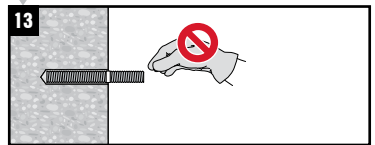
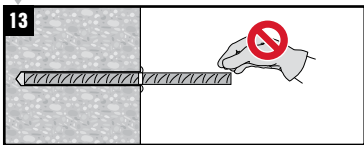
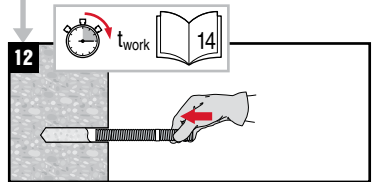
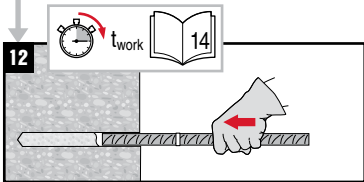
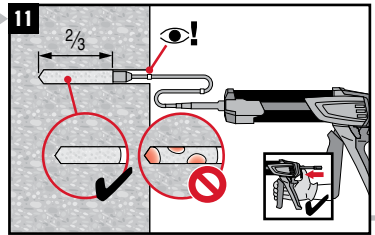
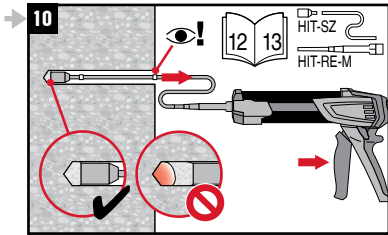

8

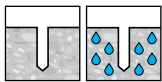
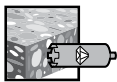

d_0 :
 $7/16'' \dots 1 1/2''$
 10...40 mm

h_{ef} :
 $2 3/8'' \dots 75''$
 60...1920 mm

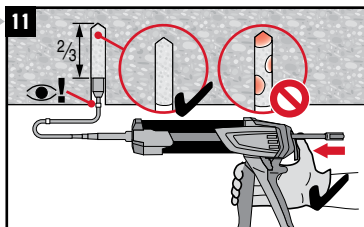
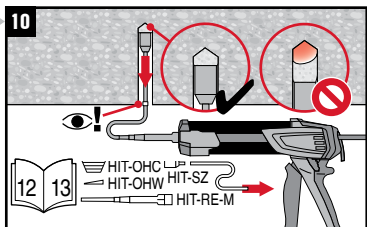
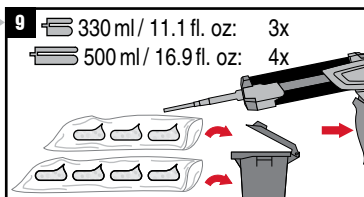
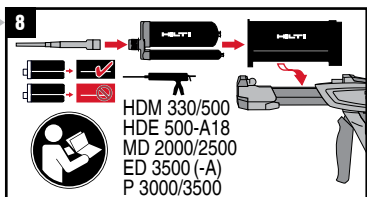
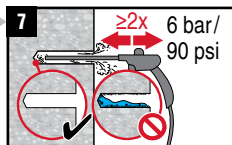
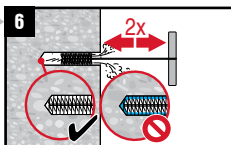
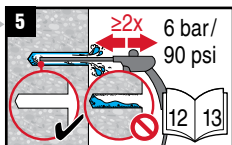
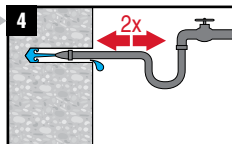
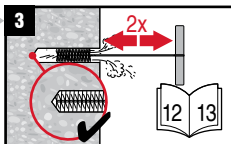
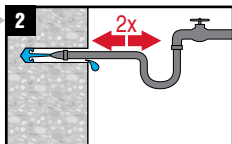
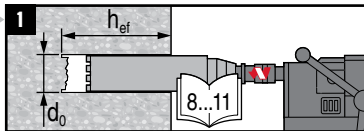

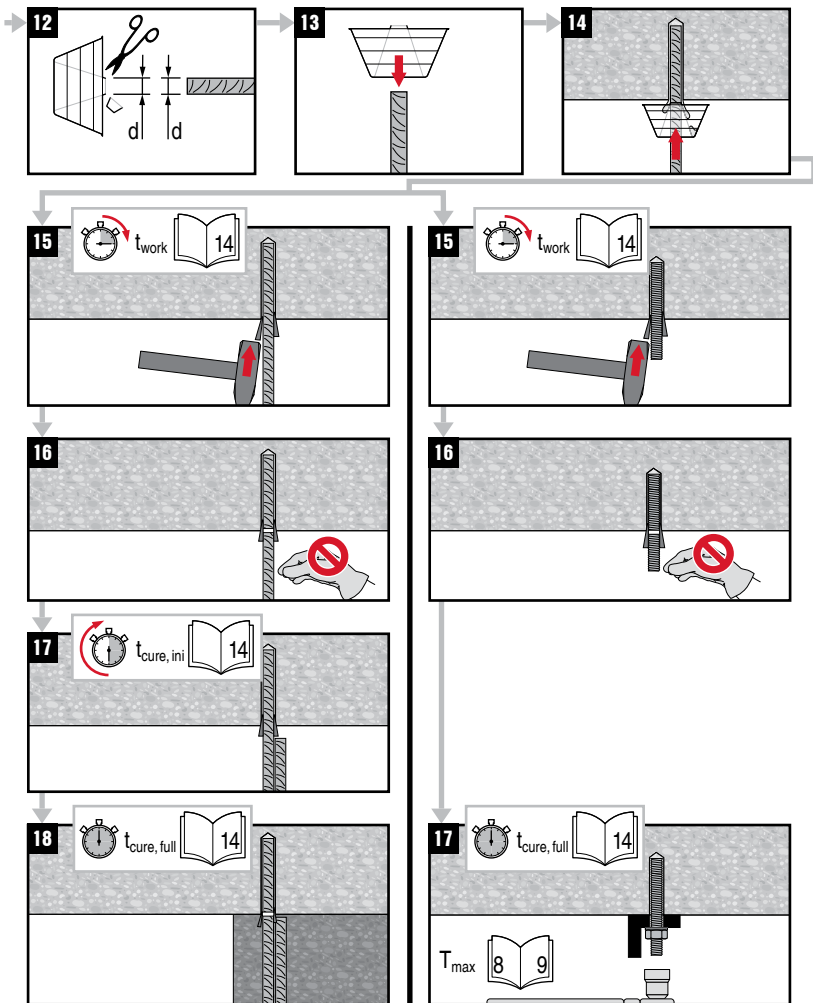

9



d_0 :
 $7/16'' \dots 1 1/2''$
 10...40 mm

h_{ef} :
 $2 3/8'' \dots 75''$
 60...1920 mm

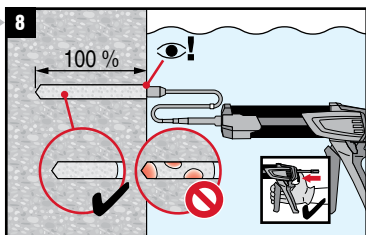
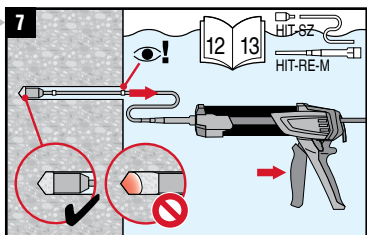
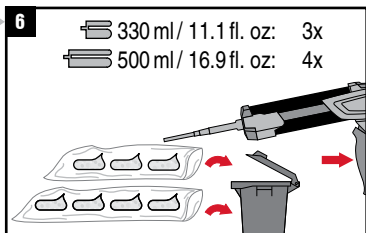
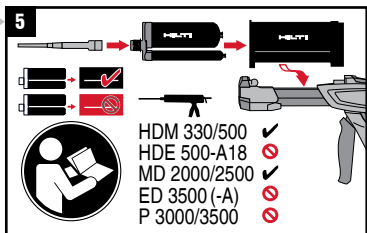
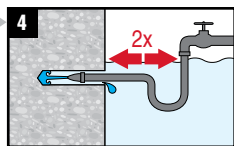
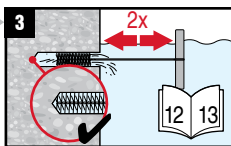
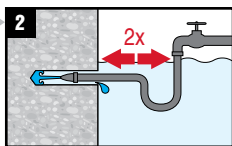
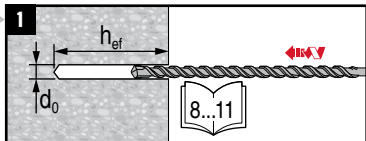
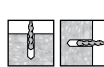

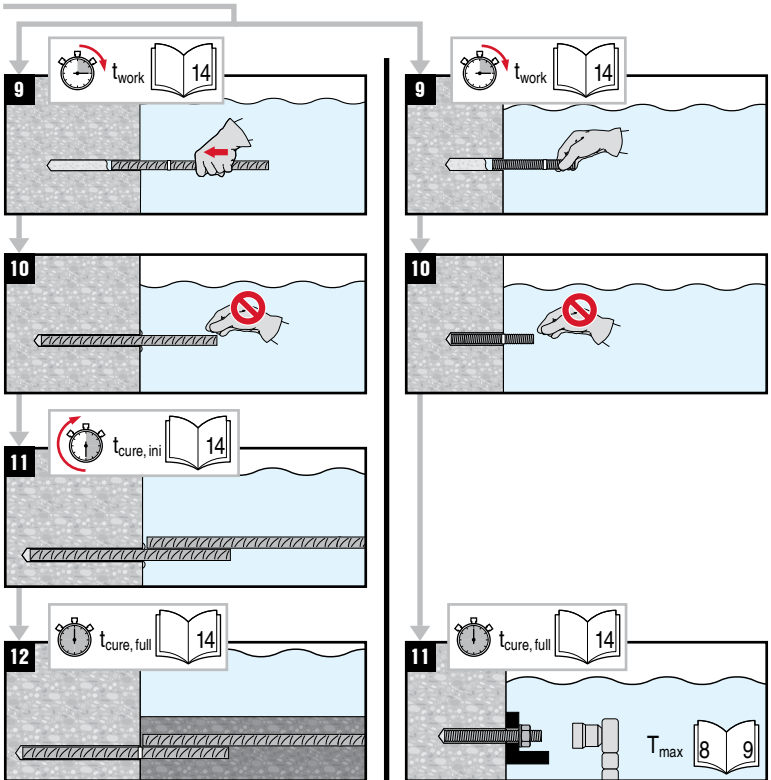

10

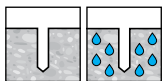
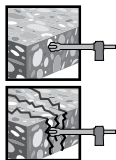

d_0 :
 $\frac{1}{2}$... $1 \frac{1}{8}$ "
 12...32 mm

h_{ef} :
 $2 \frac{3}{8}$ " ... 10"
 60...250 mm

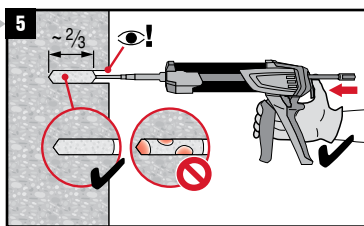
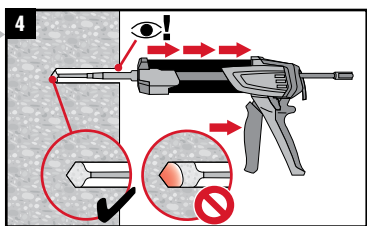
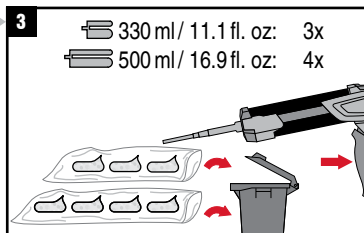
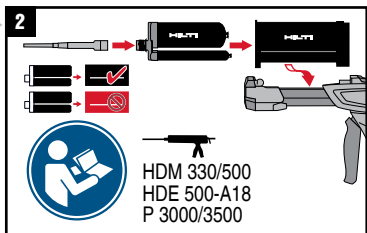
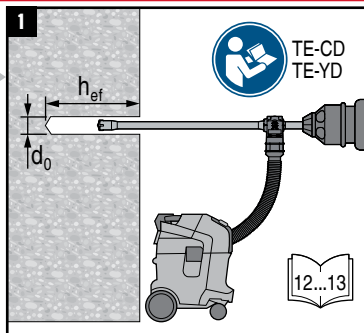
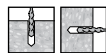

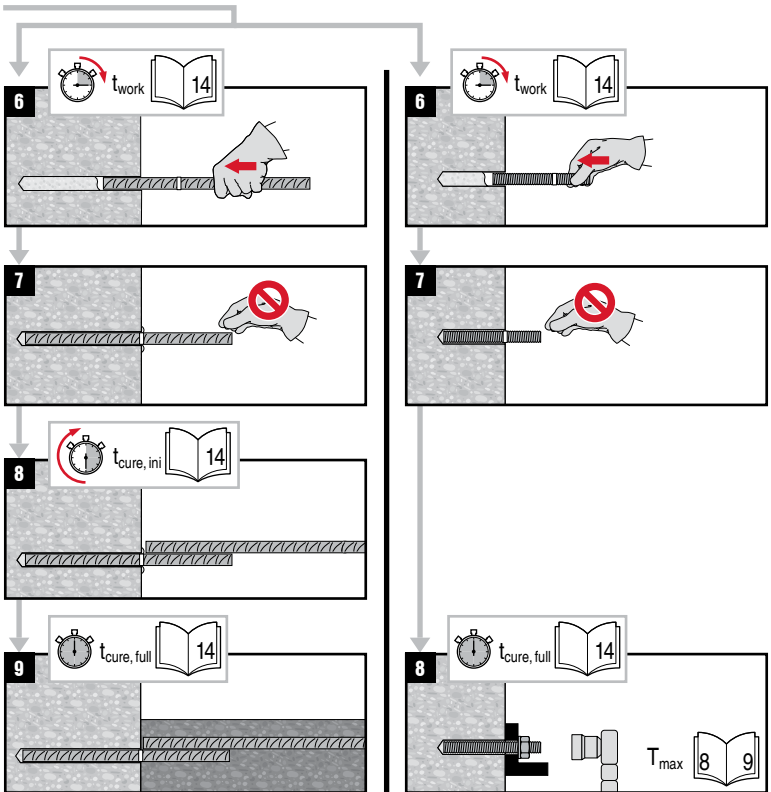

11

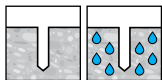
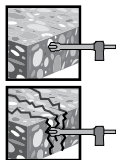

d_0 :
 $\frac{1}{2}'' \dots 1 \frac{1}{8}''$
 12...32 mm

h_{ef} :
 $2 \frac{3}{8}'' \dots 39 \frac{3}{8}''$
 60...1000 mm

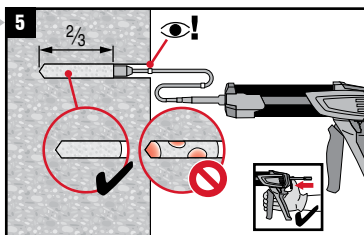
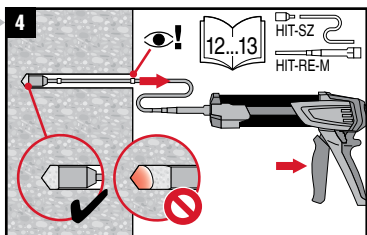
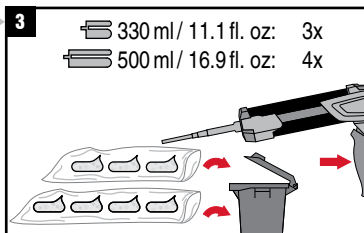
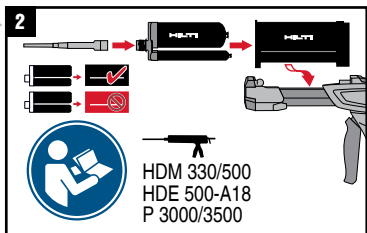
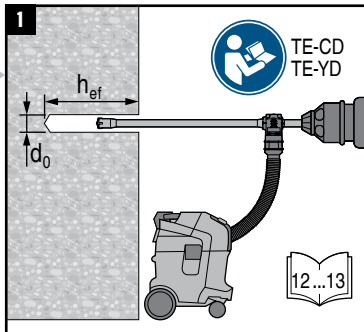
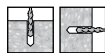

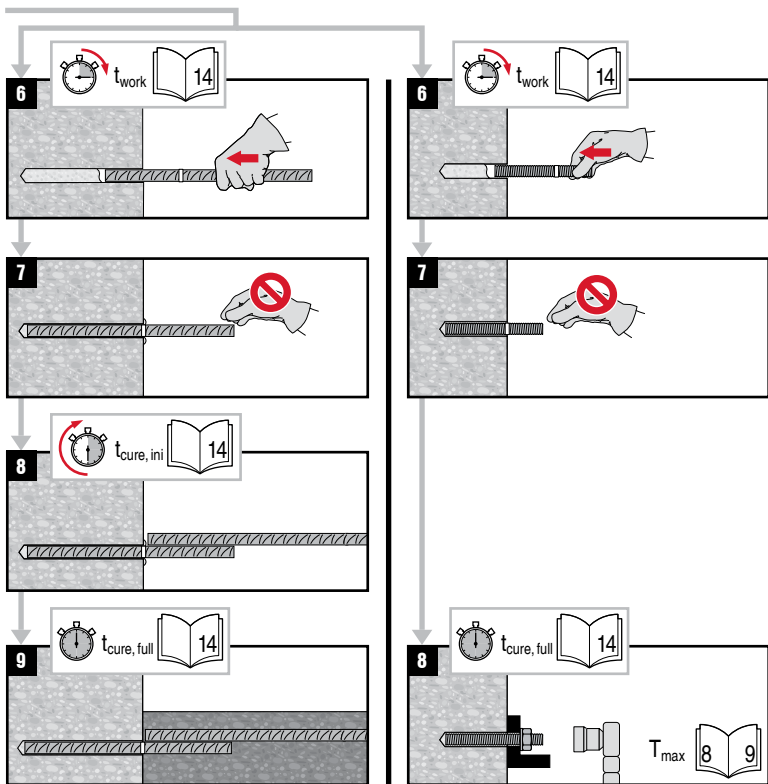

12

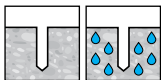
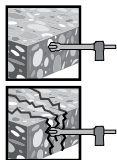

d_0 :
 $\frac{1}{2}$ " ... $1 \frac{1}{8}$ "
 12...32 mm

h_{ef} :
 $2 \frac{3}{8}$ " ... $39 \frac{3}{8}$ "
 60...1000 mm

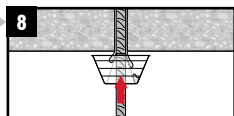
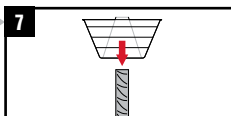
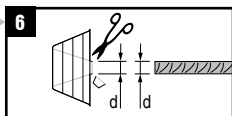
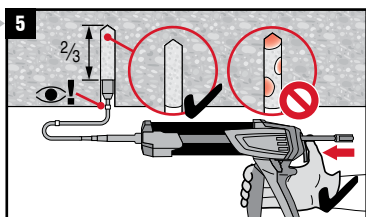
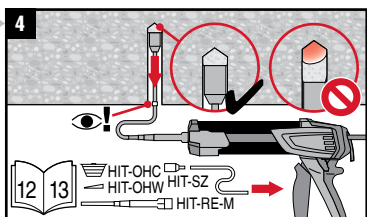
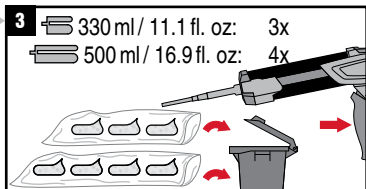
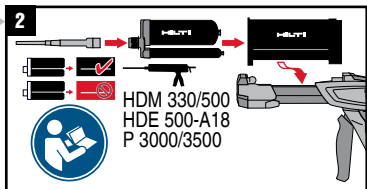
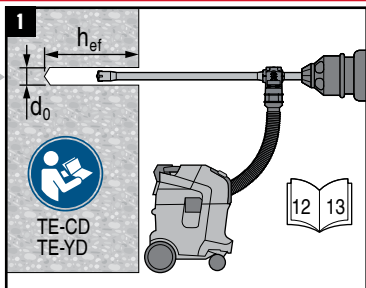

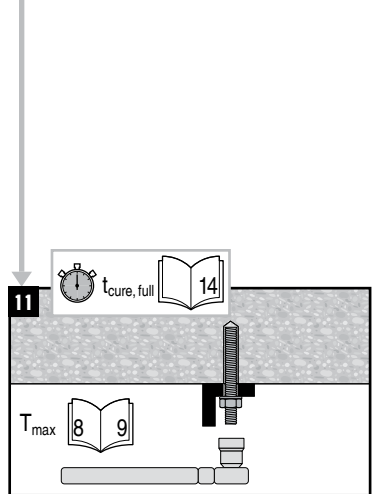
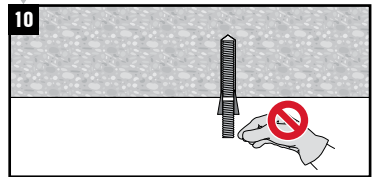
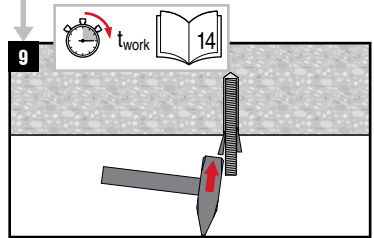
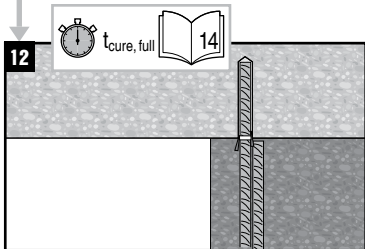
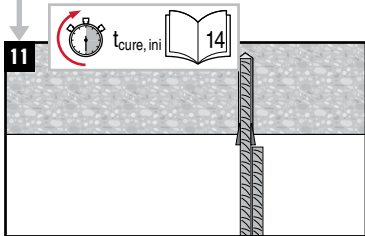
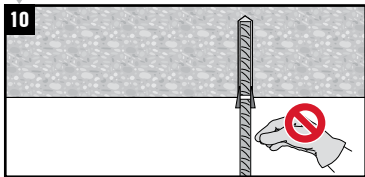
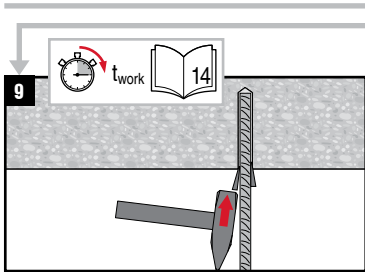

Adhesive anchoring system for rebar and anchor fastenings in concrete

- ▶ Prior to use of product, follow the instructions for use and the legally obligated safety precautions.
- ▶ See the Safety Data Sheet for this product.

Hilti HIT-RE 500

Contains epoxy constituents. May produce an allergic reaction.(A)

Contains: reaction product: bisphenol-A-(epichlorhydrin) epoxy resin MW ≤ 700 (A), reaction product: bisphenol-F epichlorhydrin resin MW≤700 (A), m-xylenediamine,(B)



(B)



(A,B)



(A)



Danger

H314	Causes severe skin burns and eye damage.(B)
H317	May cause an allergic skin reaction.(A,B)
H411	Toxic to aquatic life with long lasting effects.(A)

P280	Wear protective gloves/protective clothing/eye protection/face protection.
P260	Do not breathe vapours.

P303+P361+P353 IF ON SKIN (or hair): Remove/Take off immediately all contaminated clothing. Rinse skin with water/shower.

P305+P351+P338 IF IN EYES: Rinse cautiously with water for several minutes. Remove contact lenses, if present and easy to do. Continue rinsing.

P333+P313 If skin irritation or rash occurs: Get medical advice/attention.

P337+P313 If eye irritation persists: Get medical advice/attention.

Recommended protective equipment:

Eye protection: Tightly sealed safety glasses e.g.: #02065449 Safety glasses PP EY-CA NCH clear; #02065591 Goggles PP EY-HA R HC/AF clear;

Protective gloves: EN 374 ; Material of gloves: Nitrile rubber, NBR

Avoid direct contact with the chemical/ the product/ the preparation by organizational measures.

Final selection of appropriate protective equipment is in the responsibility of the user

Disposal considerations

Empty packs:

- ▶ Leave the Mixer attached and dispose of via the local Green Dot collecting system
 - or EAK waste material code 15 01 02 plastic packaging.



Full or partially emptied packs:

- ▶ dispose of as special waste in accordance with official regulations.
 - EAK waste material code: 20 01 27* paint, inks, adhesives and resins containing dangerous substances.
 - or waste material code: EAK 08 04 09* waste adhesives and sealants containing organic solvents or other dangerous substances.

Content: 330 ml / 11.1 fl.oz 500 ml / 16.9 fl.oz

Weight: 480 g / 16.9 oz 727 g / 25.6 oz

Warranty: Refer to standard Hilti terms and conditions of sale for warranty information.

Failure to observe these installation instructions, use of non-Hilti anchors, poor or questionable concrete conditions, or unique applications may affect the reliability or performance of the fastenings.

Product Information

- Always keep this instruction for use together with the product.
- Ensure that the instruction for use is with the product when it is given to other persons.
- **Safety Data Sheet:** Review the DS before use.
- **Check expiration date:** See expiration date imprint on foilpack manifold (month/year). Do not use expired product.
- **Foil pack temperature during usage:** +5 °C to 40 °C / 41 °F to 104 °F.
- **Conditions for transport and storage:** Keep in a cool, dry and dark place between +5 °C to 25 °C / 41 °F to 77 °F.
- For any application not covered by this document / beyond values specified, please contact Hilti.
- **Partly used foil packs must be used up within 4 weeks.** Leave the mixer attached on the foil pack manifold and store under the recommended storage conditions. If reused, attach a new mixer and discard the initial quantity of anchor adhesive.

WARNING

! Improper handling may cause mortar splashes. Eye contact with mortar may cause irreversible eye damage!

- Always wear tightly sealed safety glasses, gloves and protective clothes before handling the mortar!
- Never start dispensing without a mixer properly screwed on.
- Attach a new mixer prior to dispensing a new foil pack (snug fit).
- Caution! Never remove the mixer while the foil pack system is under pressure. Press the release button of the dispenser to avoid mortar splashing.
- Use only the type of mixer supplied with the adhesive. Do not modify the mixer in any way.
- Never use damaged foil packs and/or damaged or unclean foil pack holders.

! Poor load values / potential failure of fastening points due to inadequate borehole cleaning. The boreholes must be dry and free of debris, dust, water, ice, oil, grease and other contaminants prior to adhesive injection.

- For blowing out the borehole - blow out with oil free air until return air stream is free of noticeable dust.
- For flushing the borehole - flush with water line pressure until water runs clear.
- Important! Remove all water from the borehole and blow out with oil free compressed air until borehole is completely dried before mortar injection (not applicable to hammer drilled hole in underwater application).

! Ensure that boreholes are filled from the back of the boreholes without forming air voids.

- If necessary, use the accessories / extensions to reach the back of the borehole.
- For overhead applications use the overhead accessories HIT-SZ / IP and take special care when inserting the fastening element. Excess adhesive may be forced out of the borehole. Make sure that no mortar drips onto the installer.
- If a new mixer is installed onto a previously-opened foil pack, the first trigger pulls must be discarded.
- A new mixer must be used for each new foil pack.

Resina de inyección para la fijación de anclajes y tacos en hormigón

- ▶ Lea estas instrucciones de uso y observe las indicaciones de seguridad antes de utilizar el producto.
- ▶ Consulte con las Hoja de datos de seguridad para este producto.

Hilti HIT-RE 500

Contiene componentes epoxídicos. Puede provocar una reacción alérgica. (A)

Contiene: producto de reacción: bisfenol-A-epiclorhidrina resinas epoxi MW ≤ 700 (A), producto de reacción: bisfenol-F-epiclorhidrina resinas epoxi MW ≤ 700 (A), m-fenilenbis(metilamina) (B)



(B)



(A,B)



(A)



Peligro

- H314 Provoca quemaduras graves en la piel y lesiones oculares graves.(B)
 H317 Puede provocar una reacción alérgica en la piel.(A, B)
 H411 Tóxico para los organismos acuáticos, con efectos nocivos duraderos.(A)

- P280 Llevar guantes/prendas/gafas/máscara de protección.
 P260 No respirar el los vapores.

P303+P361+P353 EN CASO DE CONTACTO CON LA PIEL (o el pelo): Quitarse inmediatamente las prendas contaminadas. Aclararse la piel con agua o ducharse.

P305+P351+P338 EN CASO DE CONTACTO CON LOS OJOS: Aclarar cuidadosamente con agua durante varios minutos. Quitar las lentes de contacto, si lleva y resulta fácil. Seguir aclarando.

- P333+P313 En caso de irritación o erupción cutánea: Consultar a un médico.
 P337+P313 Si persiste la irritación ocular: Consultar a un médico.

Equipo de protección recomendado:

Protección de ojos: gafas de protección herméticas p. ej. gafas de seguridad PP EY-CA NCH claras, código #02065449; gafas protectoras PP EY-HA R HC/AF claras, código #02065591.

Protección de manos: EN 374; material de los guantes: caucho nitrílico (NBR). Tome las medidas oportunas para evitar el contacto directo con la sustancia química/el producto/el preparado.

El usuario es el responsable final de la elección de un equipo de protección apropiado.

Indicaciones de reciclaje

Cartuchos vacíos:

- ▶ Deseche el mezclador enroscado a través los sistemas de recogida nacionales identificados con el Punto Verde
 - o el código de residuo LER: 15 01 02 embalajes de plastic.



Cartuchos llenos o parcialmente vacíos:

- ▶ Deberán eliminarse como residuos especiales de acuerdo con las normativas oficiales.
 - Código de residuo LER: 20 01 27* Pinturas, tintas, adhesivos y resinas que contienen sustancias peligrosas.
 - o el código de residuo LER: 08 04 09* Residuos de adhesivos y sellantes que contienen disolventes orgánicos u otras sustancias peligrosas.

Contenido: 330 ml / 11.1 fl.oz 500 ml / 16.9 fl.oz

Peso: 480 g / 16.9 oz 727 g / 25.6 oz

Garantía Para información sobre la garantía, consultar las condiciones de venta estándar de Hilti.

La inobservancia de las instrucciones de instalación, el uso de anclajes que no sean Hilti, malas o dudosas condiciones del hormigón y/o aplicaciones inadecuadas pueden afectar la fiabilidad y respuesta de las fijaciones.

ES

Información de producto

- Guarde siempre estas instrucciones de uso junto con el producto.
- En caso de entregar el producto a terceros, deben incluirse siempre las instrucciones de uso.
- **Hoja de datos de seguridad:** consulte la hoja de datos de seguridad antes de utilizar el producto.
- **Fecha de caducidad:** compruebe la fecha de caducidad (mes/año) de la pieza de conexión del cartucho. El producto no debe utilizarse después de la fecha de caducidad.
- **Temperatura del cartucho durante la utilización:** de +5 °C a 40 °C / de 41 °F a 104 °F.
- **Condiciones de transporte y almacenamiento:** lugar fresco, seco y oscuro con una temperatura de +5 °C a 25 °C / de 41 °F a 77 °F.
- Para aplicaciones que no se describen en las presentes instrucciones de uso o no se enmarcan en la especificación, póngase en contacto con Hilti.
- **Los cartuchos que no estén completamente vacíos deberán utilizarse antes de cuatro semanas.** Para ello deberán guardarse con el mezclador enroscado en las condiciones de almacenamiento recomendadas. Antes de utilizarlo de nuevo, enroscar un nuevo mezclador y desechar la resina inicial.

ADVERTENCIA

! La resina puede salpicar si se utiliza incorrectamente. El contacto de la resina con los ojos puede causar daños oculares permanentes.

- Lleve gafas protectoras herméticas, guantes de protección y ropa de trabajo durante el trabajo.
- No comience a exprimir si no se ha enroscado el mezclador.
- Enrosque un mezclador nuevo antes de exprimir un cartucho nuevo. Asegúrese de que el asiento sea firme.
- ¡Precaución! No desatornille nunca el mezclador cuando el sistema se encuentre bajo presión. Presione de antemano la tecla de desbloqueo en el aparato para evitar que siga saliendo resina.
- Utilice exclusivamente el modelo de mezclador suministrado con la resina. No modifique el mezclador en ningún caso.
- No utilice cartuchos en mal estado ni portacartuchos dañados o sucios.

! Valores de sujeción deficientes/fallo de la fijación debido a limpieza insuficiente del taladro. Antes de inyectar la resina, los taladros deben estar secos y libres de restos de perforación, polvo, agua, hielo, aceite, grasa o cualquier otro agente contaminante.

- Soplado a presión del taladro: limpie el taladro con aire a presión sin aceite hasta que el aire de retorno esté libre de polvo.
- Lavado del taladro: lave con una manguera de agua con la presión normal de la red hasta que salga agua limpia.
- ¡Atención! Antes de añadir la resina es necesario extraer el agua del taladro y limpiar el taladro con aire a presión sin aceite hasta que quede completamente seco (no aplica para agujeros realizados con taladros de percusión en aplicaciones sumergidas en agua).

! Verificar que el relleno del taladro se produce desde el fondo del taladro para que no se formen burbujas de aire.

- Si es necesario, utilice las prolongaciones para alcanzar el fondo del taladro.
- En aplicaciones por encima de la cabeza, utilice el accesorio HIT-SZ/IP y preste especial atención al introducir el elemento de fijación. Puede salir resina sobrante del taladro. Asegúrese de que la resina no gotee sobre el usuario.
- Si se enrosca un nuevo mezclador en un cartucho ya abierto, las primeras aplicaciones deben también desecharse.
- Utilice un nuevo mezclador para cada cartucho nuevo.

Mortier de scellement pour ancrage de chevilles et d'armatures dans le béton

- ▶ Avant toute utilisation, bien lire le présent mode d'emploi ainsi que les directives de sécurité qui y sont mentionnées.
- ▶ Se reporter à la Fiche de données de sécurité.

Hiti HIT-RE 500

Contient des composés époxydiques. Peut produire une réaction allergique.(A)

Contient: produit de réaction: bisphénol-A-épichlorhydrine résines époxydiques MW≤700 (A), produit de réaction: bisphénol-F-épichlorhydrine résines époxydiques MW≤ 700 (A), m-phénylenebis(méthylamine) (B)



(B)



(A,B)



(A)



Danger

- H314 Provoque des brûlures de la peau et des lésions oculaires graves.(B)
H317 Peut provoquer une allergie cutanée.(A,B)
H411 Toxique pour les organismes aquatiques, entraîne des effets néfastes à long terme.(A)

P280 Porter des gants de protection/des vêtements de protection/un équipement de protection des yeux/du visage.

P260 Ne pas respirer les vapeurs.

P303+P361+P353 EN CAS DE CONTACT AVEC LA PEAU (ou les cheveux): enlever immédiatement les vêtements contaminés. Rincer la peau à l'eau/se doucher.

P305+P351+P338 EN CAS DE CONTACT AVEC LES YEUX: rincer avec précaution à l'eau pendant plusieurs minutes. Enlever les lentilles de contact si la victime en porte et si elles peuvent être facilement enlevées.Continuer à rincer.

P333+P313 En cas d'irritation ou d'éruption cutanée: consulter un médecin.

P337+P313 Si l'irritation oculaire persiste: consulter un médecin.

Équipement de protection recommandé :

Protection des yeux : Lunettes de protection hermétiques p. ex. : réf. 02065449 Lunettes de sécurité PP EY-CA NCH claires ; réf. 02065591 Masque de protection PP EY-HA R HC/AF clair ;

Protection des mains : EN 374 Éviter un contact direct avec le produit chimique / le produit / la préparation à l'aide de mesures d'organisation.

Le choix final de l'équipement de protection adéquat relève de la seule responsabilité de l'utilisateur.

Indications de recyclage

Emballages vides

- ▶ Laisser la buse mélangeuse vissée et procéder à l'élimination par le biais du système de collecte national Point Vert.
 - ou code déchets EAK : 15 01 02 Emballages en plastique.

Emballages pleins/à moitié vides :

- ▶ Les apporter à un centre de collecte des matières dangereuses conformément aux dispositions administratives.
 - Code déchets EAK : 20 01 27* Peintures, encres d'impression, colles et résines artificielles, contenant des substances dangereuses.
 - ou code déchets EAK : 08 04 09* Résidus de colles et composants pour joints, contenant des solvants organiques ou d'autres substances dangereuses.

Contenu : 330 ml / 11.1 fl.oz 500 ml / 16.9 fl.oz

Poids : 480 g / 16.9 oz 727 g / 25.6 oz

Garantie: pour tous détails concernant la garantie, consulter les conditions de vente Hilti.

Le non respect de ces instructions de pose, l'utilisation de chevilles autres qu'Hilti, la pose dans un béton faible ou matériau ou des applications particulières peuvent avoir un impact sur la sécurité et la performance de la fixation.

Information produit

- Le présent mode d'emploi doit toujours être conservé avec le produit.
- Ne pas donner le produit à un autre utilisateur sans lui fournir le mode d'emploi.
- **Fiche de données de sécurité :** Avant toute utilisation, prendre connaissance des informations de sur les matériaux.
- **Date de péremption :** Contrôler la date de péremption (mois/année) imprimée sur le raccord de la cartouche. Ne plus utiliser un produit dont la date de péremption est dépassée.
- **Température des recharges en cours d'utilisation :** de +5 °C à 40 °C / 41 °F à 104 °F.
- **Conditions de transport et de stockage :** dans un endroit frais, sec et à l'abri de la lumière à une température de +5 °C à 25 °C / 41 °F à 77 °F.
- En cas d'applications qui ne sont pas décrites dans le présent mode d'emploi ou hors plage de valeurs spécifiées, s'adresser à Hilti.
- **Les cartouches souples entamées doivent être réutilisées dans les quatre semaines.** Laisser la buse mélangeuse vissée sur la recharge entamée et stocker la recharge conformément à la réglementation. Avant réutilisation, visser une nouvelle buse mélangeuse et jeter le mortier extrudé lors des premières pressions.



AVERTISSEMENT

! En cas de maniement non conforme, il y a risque de projection du mortier. Tout contact des yeux avec le mortier peut entraîner des lésions irréversibles !

- Lors du travail, porter une protection des yeux étanche, des gants et des vêtements de protection !
- Ne jamais commencer l'extrusion si la buse mélangeuse n'est pas vissée !
- Avant de commencer l'extrusion d'une nouvelle cartouche souple, visser une nouvelle buse mélangeuse. Vérifier qu'elle est bien en place.
- Attention ! Ne jamais dévisser la buse mélangeuse lorsque le système est sous pression. Actionner préalablement la touche de déverrouillage sur le pistolet à injecter pour éviter des éclaboussures inopinées de mortier.
- Utiliser exclusivement le type de mélangeur fourni avec le mortier. Ne modifier la buse mélangeuse en aucun cas.
- Ne jamais utiliser de cartouches souples endommagées ni de porte-cartouches endommagés/très encrassés.

! Mauvaise fixation/défaillance du chevillage à cause d'un nettoyage insuffisant du trou foré. Avant de procéder à l'injection, s'assurer que le trou foré est exempt de débris de perçage, poussières, eau, glace, huile, graisse ou autres contaminants.

- Soufflage du trou foré – souffler avec de l'air comprimé exempt d'huile, jusqu'à ce que l'air sortant soit exempt de toute poussière.
- Rinçage du trou foré – rincer le trou à l'eau à pression de conduite normale jusqu'à ce que de l'eau propre ressorte.
- Important ! Avant de remplir de mortier, évacuer l'eau du trou foré et le souffler avec de l'air comprimé exempt d'huile jusqu'à ce qu'il soit entièrement sec (Ne convient pas au trous forés au perforateur à percussion lors d'applications subaquatiques).

! Veiller à ce que le remplissage se fasse à partir du fond du trou foré pour éviter la formation de bulles d'air.

- Si nécessaire, utiliser des prolongateurs pour atteindre le fond du trou.
- En cas d'applications au plafond, utiliser l'accessoire HIT-SZ/IP et faire particulièrement attention lors de l'introduction de l'élément de fixation. L'excédent de mortier peut ressortir du trou foré. Veiller alors à ce que celui-ci ne goutte pas sur l'opérateur.
- Si une nouvelle buse mélangeuse est utilisée avec une cartouche déjà entamée, jeter également les premières pressions de mortier extrudé.
- Utiliser une nouvelle buse mélangeuse pour chaque cartouche souple neuve.

Sistema de ancoragem química para a fixação de ferros de armadura e ancoragens em betão

- ▶ Antes de utilizar este produto, siga as instruções de utilização e as precauções de segurança obrigatórias por lei.
- ▶ Consulte a Ficha de Informação de Segurança de Produtos Químicos para este produto.

Hiti HIT-RE 500

Contém componentes epoxídicos. Pode provocar uma reacção alérgica.(A)

Contém: poly[(phenyl glycidyl ether)-co-formaldehyde](A), produto de reacção: bisfenol-A-(epicloridrina) MGs700 (A); m-fenilenobis(metilamina) (B)



(B)



(A,B)



(A)



Perigo

- H314 Provoca queimaduras na pele e lesões oculares graves.(B)
H317 Pode provocar uma reacção alérgica cutânea.(A,B)
H411 Tóxico para os organismos aquáticos com efeitos duradouros.(A)

- P280 Usar luvas de protecção/vestuário de protecção/protecção ocular/protecção facial.
P260 Não respirar as vapores.

P303+P361+P353 SE ENTRAR EM CONTACTO COM A PELE (ou o cabelo): espir/retirar imediatamente toda a roupa contaminada. Enxaguar a pele com água/tomar um duche.

P305+P351+P338 SE ENTRAR EM CONTACTO COM OS OLHOS: enxaguar cuidadosamente com água durante vários minutos. Se usar lentes de contacto, retire-as, se tal lhe for possível. Continuar a enxaguar.

P333+P313 Em caso de irritação ou erupção cutânea: consulte um médico.

P337+P313 Caso a irritação ocular persista: consulte um médico.

Equipamento de protecção recomendado:

Protecção dos olhos: óculos de protecção por ex.: #02065449 Óculos de segurança PP EY-CA NCH claro; #02065591 Goggles PP EY-HA R HC/AF claro;

Protecção das mãos: EN 374 ; Deve-se evitar o contacto directo com o químico / o produto / o preparado através de medidas organizadas.

A escolha final dos equipamentos de protecção apropriados é da responsabilidade do utilizador

Nota sobre reciclagem

Cartuchos vazios

- ▶ Deixar o misturador enroscado e remover através dos sistemas de recolha nacionais, Ponto Verde
– ou Código CER: 150102 Embalagens de plastic.



Cartuchos semiusados/novos:

- ▶ Remover de acordo com as normas e regulamentações legais sobre resíduos especiais.
 - Código CER: 20 01 27* Tintas, produtos adesivos, colas e resinas, contendo substâncias perigosas.
 - ou Código CER: 08 04 09* Resíduos de colas ou vedantes, contendo solventes orgânicos ou outras substâncias perigosas.

Conteúdo: 330 ml / 11.1 fl.oz 500 ml / 16.9 fl.oz

Peso: 480 g / 16.9 oz 727 g / 25.6 oz

Garantia: Para informações sobre a garantia, consulte os termos e condições de venda padrão da Hilti.

O não cumprimento destas instruções de colocação, a utilização de ancoragens que não sejam da Hilti, as condições fracas ou duvidosas do betão, ou aplicações fora do comum podem afectar a segurança ou a eficácia das fixações.

pt

Dados informativos sobre o produto

- Guarde estas instruções de utilização sempre em conjunto com o produto.
- Entregue o produto a outras pessoas apenas juntamente com as instruções de utilização.
- **Ficha de Informação de Segurança de Produtos Químicos:** antes de iniciar os trabalhos, tenha em consideração a Ficha de Informação de Segurança de Produtos Químicos*
- **Prazo de validade:** veja o prazo de validade (mês/ano) na peça de junção do cartucho. Não utilize produtos cujo prazo de validade se encontre ultrapassado.
- **Temperatura do cartucho durante a utilização:** entre +5 °C e 40 °C / 41 °F e 104 °F.
- **Condições de transporte e armazenamento:** em lugar fresco, seco e ao abrigo da luz, entre +5 °C e 25 °C / 41 °F e 77 °F.
- Em caso de aplicações que não se encontrem descritas nas presentes instruções de utilização ou estejam fora das especificações, é favor dirigir-se à Hilti.
- **As sobras de cartuchos parcialmente usados devem ser utilizadas num prazo de quatro semanas.** Deixe o misturador enroscado e armazene-o juntamente com o cartucho, de acordo com as condições de armazenagem preconizadas. Quando/se reutilizados, utilize um misturador novo e não utilize novamente a resina inicial.

AVISO

! No caso de manuseamento incorrecto, é possível que seja injectada resina. O contacto da resina com os olhos pode provocar lesões oculares permanentes!

- Durante a realização de trabalhos, use óculos de protecção que fiquem bem justos, luvas de protecção e roupa de trabalho!
- Nunca comece a aplicação sem que o misturador esteja enroscado!
- Antes da aplicação de um novo cartucho, enrosque um misturador novo. Certifique-se de que está bem apertado.
- Cuidado! Nunca desenrosque o misturador quando o sistema está sob pressão. Pressione previamente a alavanca de libertação na ferramenta para evitar projecções de resina.
- Utilize apenas o tipo de misturador fornecido com a resina. Não modifique o misturador de forma alguma.
- Nunca utilize cartuchos danificados e/ou suportes danificados ou sujos.

! Valores de retenção deficientes/falha da fixação devido a limpeza insuficiente do furo. Os furos devem estar secos e livres de material de perfuração, pó, água, gelo, óleo, gordura ou outras impurezas antes de efectuar a injeção.

- Limpar o furo por sopra – limpe o furo por sopra com ar isento de óleo, até que o ar saia sem pó.
- Lavar o furo – lave com uma mangueira com pressão normal, até sair água limpa.
- Importante! Antes de preencher com resina, retire a água do furo e sopra com ar isento de óleo até estar totalmente seco (Não utilizável em furos subaquáticos executados com percussão).

! Certifique-se de que o enchimento do furo é efectuado a partir do fundo, para que não se formem bolhas de ar.

- Se necessário, utilize os prolongadores para alcançar o fundo do furo.
- No caso de aplicações em suspensão, utilize o acessório HIT-SZ/IP e preste especial atenção ao inserir o elemento de fixação. Pode sair resina em excesso do furo. Certifique-se de que não pinga resina sobre o utilizador.
- Se for enroscado um misturador novo num cartucho já aberto, também não utilize o produto das primeiras bombadas.
- Para cada cartucho novo deverá utilizar-se um misturador novo.

- AR** Hilti Argentina S.R.L.
Profesor Manuel García 4760
B1605 BIB - Munro
AR-Buenos Aires
Tel +54 11 4721 4400
Fax +54 11 4721 4410
- BR** Hilti do Brasil Comercial Ltda.
Av. Ceci, 426-Centro
Empresarial Tamboré
06460-120 Barueri, SP
Tel +55 11 4134 9000
Fax +55 11 4134 9072
- CA** Hilti (Canada) Corp.
2360 Meadowpine Boulevard
Mississauga, Ontario L5N 6S2
Tel +1 905 813 920
Fax +1 905 813 9009
- CL** Hilti Chile Ltda.
Av. Apoquindo 4501, piso 13
Las Condes 7550000
Santiago
Tel +562 655 3000
Fax +562 426 1974
- MX** Hilti Mexicana, S.A. de C.V.
Jaime Balmes 8, Oficina 102,
1er Piso
Col. Los Morales Polanco
Del. Miguel Hidalgo
MEX-Mexico City 11510
Tel +5255 5387-1600
Fax +5255 5281 1419
- PE** Química Suiza S.A.
2577 Av. República de Panamá
Apartado 3919
PE- Lima 100
Tel +511 211 4423
Fax +51 1 211 4050
- PR** Hilti Caribe, LLC
The Palmas Village #3,
Carr. 869 KM 2, Palmas
Industrial Park
Cataño, PR 00962
Tel +1-787 936-7060
Fax +1 787 936-7065
- US** Hilti Inc.
5400 South 122nd East Ave.
US-Tulsa, OK 74146
Tel +1 918 872 3000
Fax +1 918 254 0522
- VE** Hilti Venezuela, S.A.
Calle Pascuale Giorgio, 3era.
Transversal, Edf. Segre,
2do Piso, Ala Norte, Los Ruices
VE-Caracas 1071
Tel +58 212 232 42 43
Fax +58 212 203 4310

Info | Shop



[http://hilti15.pxltv.net/
toolselector2/index.php](http://hilti15.pxltv.net/toolselector2/index.php)



Certified to
ANSI-NSF 61

www.hilti.com

Made in Germany

Hilti = registered trademark of Hilti Corporation, Schaan, Liechtenstein

© 2012

Right of technical changes reserved S.E. & O,