

HILTI

TE 3000-AVR

English



1 Information about the documentation



1.1 About this documentation

- Read this documentation before initial operation or use. This is a prerequisite for safe, trouble-free handling and use of the product.
- Observe the safety instructions and warnings in this documentation and on the product.
- Always keep the operating instructions with the product and make sure that the operating instructions are with the product when it is given to other persons.

1.2 Explanation of symbols used



1.2.1 Warnings

Warnings alert persons to hazards that may occur when handling or using the product. The following signal words are used in combination with a symbol:

	DANGER! Draws attention to an imminent hazard that will lead to serious personal injury or fatality.
	WARNING! Draws attention to a potential hazard that could lead to serious personal injury or fatality.
	CAUTION! Draws attention to a potentially dangerous situation that could lead to minor personal injury or material damage.



1.2.2 Symbols in the documentation

The following symbols are used in this document:

	Read the operating instructions before use
	Instructions for use and other useful information

1.2.3 Symbols in the illustrations





The following symbols are used in illustrations:

	These numbers refer to the corresponding illustrations found at the beginning of these operating instructions.
3	The numbering reflects the sequence of operations shown in the illustrations and may deviate from the steps described in the text.
	Item reference numbers are used in the overview illustration and refer to the numbers used in the key in the product overview section.
	This symbol is intended to draw special attention to certain points when handling the product.

1.3 Symbols on the product

1.3.1 Symbols on the product

The following symbols are used on the product:

	Chiseling
	Chisel positioning
	Protection class II (double-insulated)
	Transport by crane is not permissible
n_0	Rated speed under no load

1.4 Product information

Hilti products are designed for professional use and may be operated, serviced and maintained only by trained, authorized personnel. This personnel must be informed of any particular hazards that may be

encountered. The product and its ancillary equipment may present hazards when used incorrectly by untrained personnel or when used not as directed.

The type designation and serial number are printed on the type identification plate.

- ▶ Write down the serial number in the table below. You will be required to state the product details when contacting Hilti Service or your local Hilti organization to enquire about the product.

Product information

Breaker	TE 3000-AVR
Generation	02
Serial no.	

1.5 Declaration of conformity

We declare, on our sole responsibility, that the product described here complies with the applicable directives and standards. A copy of the declaration of conformity can be found at the end of this documentation.

The technical documentation is filed and stored here:

Hilti Entwicklungsgesellschaft mbH | Tool Certification | Hiltistrasse 6 | 86916 Kaufering, Germany

2 Safety

2.1 General power tool safety warnings

WARNING

Read all safety warnings and all instructions. Failure to follow the warnings and instructions may result in electric shock, fire and/or serious injury.

Save all warnings and instructions for future reference.

The term “power tool” in the warnings refers to your mains-operated (corded) power tool or battery-operated (cordless) power tool.

Work area safety

- ▶ **Keep work area clean and well lit.** Cluttered or dark areas invite accidents.
- ▶ **Do not operate power tools in explosive atmospheres, such as in the presence of flammable liquids, gases or dust.** Power tools create sparks which may ignite the dust or fumes.
- ▶ **Keep children and bystanders away while operating a power tool.** Distractions can cause you to lose control.

Electrical safety

- ▶ **Power tool plugs must match the outlet. Never modify the plug in any way. Do not use any adapter plugs with earthed (grounded) power tools.** Unmodified plugs and matching outlets will reduce risk of electric shock.
- ▶ **Avoid body contact with earthed or grounded surfaces, such as pipes, radiators, ranges and refrigerators.** There is an increased risk of electric shock if your body is earthed or grounded.
- ▶ **Do not expose power tools to rain or wet conditions.** Water entering a power tool will increase the risk of electric shock.
- ▶ **Do not abuse the cord. Never use the cord for carrying, pulling or unplugging the power tool. Keep cord away from heat, oil, sharp edges or moving parts.** Damaged or entangled cords increase the risk of electric shock.
- ▶ **When operating a power tool outdoors, use an extension cord suitable for outdoor use.** Use of a cord suitable for outdoor use reduces the risk of electric shock.
- ▶ **If operating a power tool in a damp location is unavoidable, use a residual current device (RCD) protected supply.** Use of an RCD reduces the risk of electric shock.

Personal safety

- ▶ **Stay alert, watch what you are doing and use common sense when operating a power tool. Do not use a power tool while you are tired or under the influence of drugs, alcohol or medication.** A moment of inattention while operating power tools may result in serious personal injury.
- ▶ **Use personal protective equipment. Always wear eye protection.** Protective equipment such as dust mask, non-skid safety shoes, hard hat, or hearing protection used for appropriate conditions will reduce personal injuries.
- ▶ **Prevent unintentional starting. Ensure the switch is in the off-position before connecting to power source and/or battery pack, picking up or carrying the tool.** Carrying power tools with your finger on the switch or energising power tools that have the switch on invites accidents.

- ▶ **Remove any adjusting key or wrench before turning the power tool on.** A wrench or a key left attached to a rotating part of the power tool may result in personal injury.
- ▶ **Do not overreach. Keep proper footing and balance at all times.** This enables better control of the power tool in unexpected situations.
- ▶ **Dress properly. Do not wear loose clothing or jewellery. Keep your hair, clothing and gloves away from moving parts.** Loose clothes, jewellery or long hair can be caught in moving parts.
- ▶ **If devices are provided for the connection of dust extraction and collection facilities, ensure these are connected and properly used.** Use of dust collection can reduce dust-related hazards.

Power tool use and care

- ▶ Do not force the power tool. Use the correct power tool for your application. The correct power tool will do the job better and safer at the rate for which it was designed.
- ▶ **Do not use the power tool if the switch does not turn it on and off.** Any power tool that cannot be controlled with the switch is dangerous and must be repaired.
- ▶ **Disconnect the plug from the power source and/or the battery pack from the power tool before making any adjustments, changing accessories, or storing power tools.** Such preventive safety measures reduce the risk of starting the power tool accidentally.
- ▶ **Store idle power tools out of the reach of children and do not allow persons unfamiliar with the power tool or these instructions to operate the power tool.** Power tools are dangerous in the hands of untrained users.
- ▶ **Maintain power tools. Check for misalignment or binding of moving parts, breakage of parts and any other condition that may affect the power tool's operation. If damaged, have the power tool repaired before use.** Many accidents are caused by poorly maintained power tools.
- ▶ **Keep cutting tools sharp and clean.** Properly maintained cutting tools with sharp cutting edges are less likely to bind and are easier to control.
- ▶ **Use the power tool, accessories and tool bits etc. in accordance with these instructions, taking into account the working conditions and the work to be performed.** Use of the power tool for operations different from those intended could result in a hazardous situation.

Service

- ▶ **Have your power tool serviced by a qualified repair person using only identical replacement parts.** This will ensure that the safety of the power tool is maintained.

2.2 Hammer safety warnings

- ▶ **Wear ear protectors.** Exposure to noise can cause hearing loss.
- ▶ **Use auxiliary handles, if supplied with the tool.** Loss of control can cause personal injury.
- ▶ **Hold power tool by insulated gripping surfaces, when performing an operation where the cutting accessory may contact hidden wiring or its own cord.** Cutting accessory contacting a "live" wire may make exposed metal parts of the power tool "live" and could give the operator an electric shock.

2.3 Additional safety instructions

Personal safety

- ▶ Use the tool only when it is in technically faultless condition.
- ▶ Never tamper with or modify the tool in any way.
- ▶ Apply appropriate safety measures at the opposite side of the workpiece in work that involves breaking through. Parts breaking away could fall out and / or fall down causing injury to other persons.
- ▶ Check that the side handle is fitted correctly and tightened securely. Always hold the tool securely with both hands on the grips provided. Keep the grips dry, clean and free from oil and grease.
- ▶ Take breaks between working and do physical exercises to improve the blood circulation in your fingers. Exposure to vibration during long periods of work can lead to disorders of the blood vessels and nervous system in the fingers, hands and wrists.
- ▶ The tool is not intended for use by debilitated persons who have received no special training.
- ▶ Keep the power tool out of reach of children.
- ▶ Before beginning the work, check the hazard classification of the dust that will be produced. Use an industrial vacuum cleaner with an officially approved protection classification in compliance with locally applicable dust protection regulations.
- ▶ Use a dust removal system and suitable vacuum cleaner whenever possible. Dust from materials, such as paint containing lead, some wood species, concrete/masonry/stone containing silica, and minerals as well as metal, may be harmful.
- ▶ Make sure that the workplace is well ventilated and, where necessary, wear a respirator appropriate for the type of dust generated. Contact with or inhalation of the dust may cause allergic reactions and/or

respiratory or other diseases to the operator or bystanders. Certain kinds of dust are classified as carcinogenic such as oak and beech dust, especially in conjunction with additives for wood conditioning (chromate, wood preservative). Material containing asbestos may be handled only by specialists.

Electrical safety

- ▶ Before beginning work, check the working area for concealed electric cables or gas and water pipes. You may receive an electric shock from external metal parts of the power tool if you damage an electric cable accidentally.
- ▶ Check the power tool's supply cord at regular intervals and have it replaced by a qualified specialist if found to be damaged. If the power tool's supply cord is damaged it must be replaced with a specially-prepared and approved supply cord available from Hilti Customer Service. Check extension cords at regular intervals and replace them if found to be damaged. Do not touch the supply cord or extension cord if it is damaged while working. Disconnect the supply cord plug from the power outlet. Damaged supply cords or extension cords present a risk of electric shock.
- ▶ Dirty or dusty power tools that have been used frequently for work on conductive materials should be checked at regular intervals at a **Hilti** Service Center. Dust (especially dust from conductive materials) or dampness adhering to the surface of the tool may, under unfavorable conditions, lead to electric shock.
- ▶ Switch the power tool off and unplug the supply cord in the event of a power failure or interruption in the electric supply. This will prevent accidental restarting when the electric power returns.

3 Description

3.1 Overview of the product

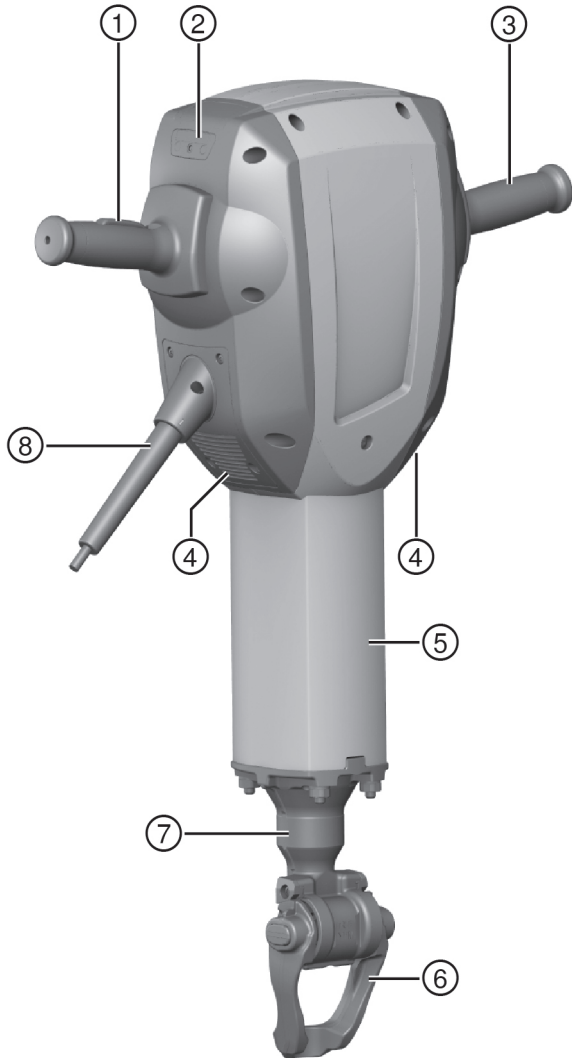

- ① On/off switch
- ② Service indicator
- ③ Grip
- ④ Air vents

- ⑤ Guide tube
- ⑥ Accessory tool retainer / locking bar
- ⑦ Chuck
- ⑧ Supply cord

3.2 Transport trolley components

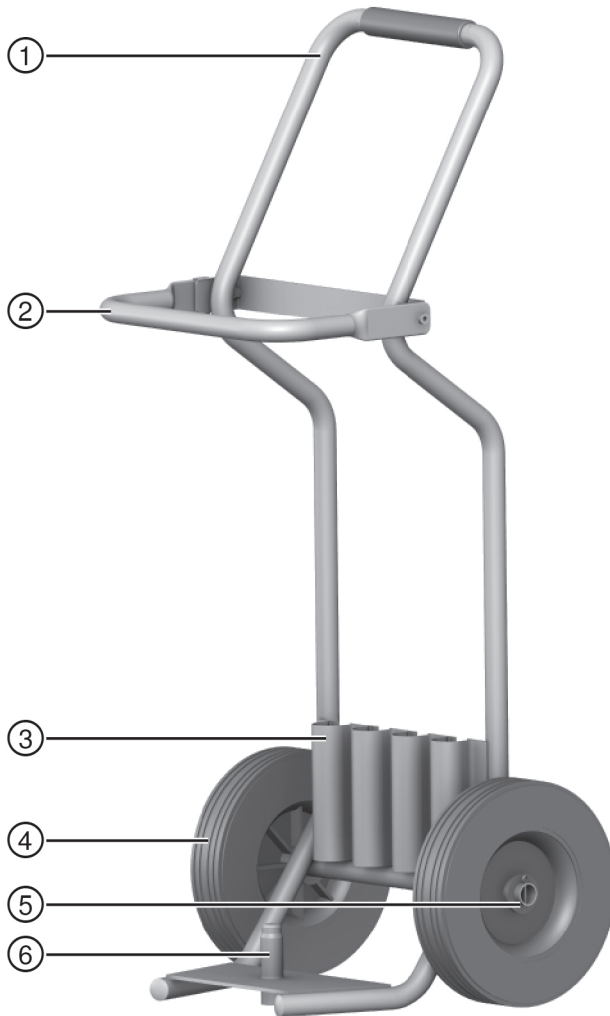

- | | |
|----------------------------------------|------------------------------------------------|
| ① Grip | ④ Wheels |
| ② Locking bar | ⑤ Wheel securing parts (washer, retaining pin) |
| ③ Holder for accessory tools (chisels) | ⑥ Power tool locating pin |

3.3 Intended use

The product described is a hand-held electric breaker with 28 mm hex chuck. It is designed for chiseling work on concrete, masonry and asphalt. Excavation and compacting are further possible applications.

- ▶ Operation is permissible only when connected to a power source providing a voltage and frequency in compliance with the information given on the type identification plate.

3.4 Possible misuse

This product is not suitable for working on hazardous materials.
This product is not suitable for working in a damp environment.

3.5 Service indicator

The breaker is equipped with a service indicator LED.

Status	Meaning
The service indicator lights red.	<ul style="list-style-type: none"> • End of service interval – servicing is due. • A fault has occurred in the tool.
The service indicator blinks red.	<ul style="list-style-type: none"> • Protection against overheating • The voltage provided by the electric supply is too high.



Note

Bring the product to **Hilti Service** in good time. This will help to ensure that it's always ready for use.

3.6 Active Vibration Reduction (AVR)

The breaker is equipped with an Active Vibration Reduction (AVR) system, which reduces vibration significantly.

3.7 Protection against overheating

The power tool is equipped with a protective overheating cut-out that switches the power off for a short time. Overheating is indicated by an LED blinking.

3.8 Items supplied

Breaker, operating instructions with bag to attach to the transport trolley, grease.
The transport trolley is available as an accessory.



Note

You can find other system products approved for your product at your local **Hilti Center** or online at: www.hilti.comgroup

4 Technical data



Note

For details of the rated voltage, frequency, current and input power, please refer to the power tool's country-specific type identification plate.

When powered by a generator or transformer, the generator or transformer's power output must be at least twice the rated input power shown on the rating plate of the power tool. The operating voltage of the transformer or generator must always be within +5% and -15% of the rated voltage of the power tool.

	TE 3000-AVR
Weight in accordance with EPTA procedure 01	29.9 kg
Single impact energy in accordance with the EPTA procedure	68 J

4.1 Noise information and vibration values in accordance with EN 60745

The sound pressure and vibration values given in these instructions have been measured in accordance with a standardized test and may be used to compare one power tool with another. They may be used for a preliminary assessment of exposure.

The data given represents the main applications of the power tool. However, if the power tool is used for different applications, with different accessory tools or is poorly maintained, the data may vary. This may significantly increase exposure over the total working period.

An accurate estimation of exposure should also take into account the times when the power tool is switched off, or when it is running but not actually being used for a job. This may significantly reduce exposure over the total working period.

Identify additional safety measures to protect the operator from the effects of noise and/or vibration, for example: Maintaining the power tool and accessory tools, keeping the hands warm, organization of work patterns.

Noise information

Sound (power) level (L_{WA})	105 dB(A)
Uncertainty for the sound power level (K_{WA})	3 dB(A)
Sound pressure level (L_{pA})	94 dB(A)
Uncertainty for the sound pressure level (K_{pA})	3 dB(A)

Vibration information

Chiseling ($a_{h, Cheq}$)	7 m/s ²
Uncertainty (K)	1.5 m/s ²

4.2 Using extension cords



WARNING

A damaged supply cord presents a hazard! Do not touch the supply cord or extension cord if damaged while working. Disconnect the supply cord plug from the power outlet.

- ▶ Check the appliance's supply cord at regular intervals and have it replaced by a qualified specialist if found to be damaged.

- Use only extension cords of a type approved for the application and with conductors of adequate gauge (cross section). The power tool may otherwise suffer a drop in performance and the extension cord may overheat.
- Check the extension cord for damage at regular intervals.
- Replace damaged extension cords.
- When working outdoors, use only extension cords that are approved and correspondingly marked for this application.

Recommended minimum conductor cross-section and maximum power-cord length for 120V supply voltage

Cord	AWG 16	AWG 14	AWG 12	AWG 10
Conductor cross-section	1,31 mm ²	2,08 mm ²	3,31 mm ²	5,26 mm ²
Conductor cross-section	2,58 kcmil	4,11 kcmil	6,53 kcmil	10,4 kcmil
Cord length	25 m	30 m	50 m	100 m
Cord length	75 ft	100 ft	150 ft	250 ft

5 Operation

5.1 Preparations at the workplace



CAUTION

Risk of injury! Inadvertent starting of the product.

- ▶ Unplug the supply cord before making adjustments to the power tool or before changing accessories.

Observe the safety instructions and warnings in this documentation and on the product.

5.1.1 Fitting the accessory tool



Note

Check the accessory tool for damage or uneven wear each time before use and replace it if necessary. Check that the locking bar is clean and undamaged.

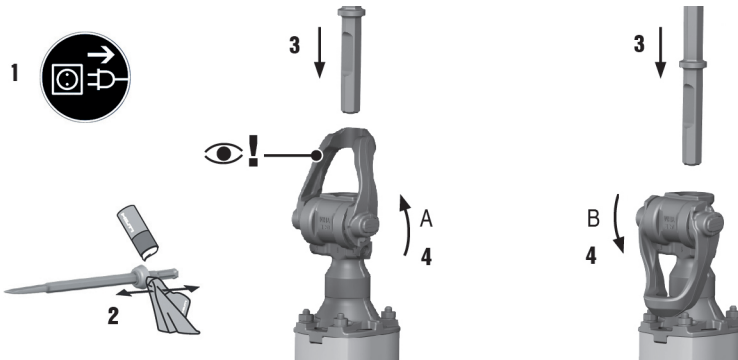

1. Apply a little grease to the connection end of the accessory tool.
2. Open the locking bar.
3. Push the accessory tool into the chuck as far as it will go.
4. For accessory tools with a collar, bring the retaining bar into locking position A.
5. For accessory tools with a locking groove, bring the retaining bar into locking position B.
 - ◀ Position the chisel so that the groove is facing locking position B.
6. Check that the chisel has engaged correctly by gripping and pulling it.
 - ◀ Insert tools with a combined connection end (with collar and groove) can be locked in position A or B, as desired.



Note

Use only the recommended grease supplied by **Hilti**. Use of unsuitable grease may cause damage to the product.

5.1.2 Removing the accessory tool



WARNING

Risk of injury! The accessory tool gets hot during use and may also have sharp edges.

- ▶ Wear protective gloves when changing the tool.



DANGER

Risk of fire! Risk of contact between the hot accessory tool and highly inflammable materials.

- ▶ Do not lay the hot accessory tool down on highly inflammable materials.



WARNING

Risk of injury! Risk of burning injuries caused by hot surfaces.

- ▶ Avoid touching the guide tube as this part gets hot through use of the power tool.

1

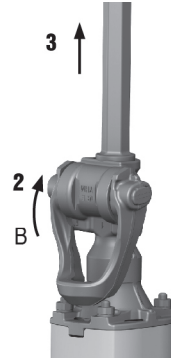
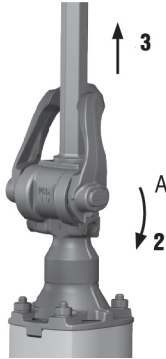

1. Open the locking bar.
2. Pull the accessory tool out of the chuck.

5.2 Types of work



WARNING

Risk of electric shock! Severe injury and burns can result if any attempt is made to operate the tool without an earth/ground conductor and ground fault circuit interrupter correctly connected.

- ▶ Irrespective of whether mains power or generator power is used, always make sure that an earth/ground conductor and ground fault circuit interrupter are present in the power supply and that these are correctly connected.
- ▶ Do not use the product unless these safety measures are in place and fully operational.



WARNING

A damaged supply cord presents a hazard! Do not touch the supply cord or extension cord if damaged while working. Disconnect the supply cord plug from the power outlet.

- ▶ Check the appliance's supply cord at regular intervals and have it replaced by a qualified specialist if found to be damaged.

Full approval must be obtained from the site engineer or architect prior to beginning the work.

5.2.1 Personal protective equipment



The user and any other persons in the vicinity must wear suitable eye protection, a hard hat, ear protection, protective gloves, safety footwear and respiratory protection while the tool is in use.

5.2.2 Chiseling

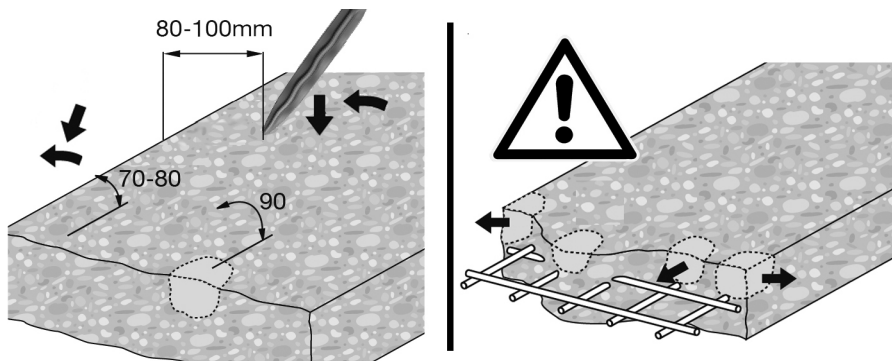

1. Plug the supply cord into the power outlet.
2. Bring the chisel into contact with the workpiece about 80 -100 mm (3 1/8" - 4") from its edge.
3. Press the on / off switch fully.
4. Begin with the chisel positioned at an angle of 70° to 80° to the concrete surface, with the tip of the chisel pointing toward the edge of the workpiece. Break material away by subsequently increasing the angle to approx. 90° as the chisel penetrates.
 - ◁ When working close to reinforcing bars, always guide the tip of the chisel toward the edge of the workpiece, not toward a reinforcing bar.



Note

Working at low temperatures:

The hammering mechanism works only when the power tool has reached a minimum operating temperature. Bring the chisel into contact with the workpiece and allow the power tool to run under no load until the required temperature is reached. If necessary, repeat this procedure until the hammering mechanism begins to operate.

6 Care and maintenance



WARNING

Danger of electric shock! Carrying out care and maintenance while the supply cord is connected to the power outlet presents a risk of serious injuries including burns.

- ▶ Always unplug the supply cord before carrying out all care and maintenance tasks.

Care

- Carefully remove stubborn dirt from the tool.
- Clean the air vents carefully with a dry brush.
- Use only a slightly damp cloth to clean the casing. Do not use cleaning agents containing silicone as they can attack the plastic parts.

Maintenance



WARNING

Danger of electric shock! Improper repairs to electrical components may lead to serious injuries including burns.

- ▶ Repairs to the electrical section of the tool or appliance may be carried out only by trained electrical specialists.

- At regular intervals, check all visible parts and the controls for signs of damage and make sure that they all function correctly.
- Do not operate the power tool if signs of damage are found or if parts malfunction. Have damage repaired immediately by Hilti Service.

- After cleaning and maintenance, refit all guards or protective devices and check that they function correctly.

7 Transport and storage

- Do not transport electric tools with accessory tools fitted.
- Always unplug the supply cord before storing an electric tool or appliance.
- Store tools and appliances in a dry place where they cannot be accessed by children or unauthorized persons.
- Check electric tools or appliances for damage after long periods of transport or storage.

7.1 Transport using the transport trolley



WARNING

Risk of injury due to high weight The breaker is heavy.

- ▶ Use the transport trolley whenever possible. If no transport trolley is available for use, the breaker should always be transported by two persons.



Note

Do not park the transport trolley on an incline.

Take care to ensure that the transport trolley stands in a steady, secure position.

Take care to use only safe transport routes.

1. Place the breaker on the locating pin on the transport trolley.
2. Secure the breaker during transport by closing the locking bar.
3. Push the chisel into the accessory tool holder until it engages.

8 Troubleshooting

If the trouble you are experiencing is not listed in this table or you are unable to remedy the problem by yourself, please contact **Hilti Service**.

8.1 Troubleshooting

Trouble or fault	Possible cause	Action to be taken
The breaker doesn't start.	Electronics initialization in progress (takes up to 4 seconds after plugging in). The electronic restart interlock is activated after an interruption in the electric supply.	▶ Switch the power tool off and then on again.
	Interruption in the electric supply.	▶ Plug in another electric tool or appliance and check whether it works.
	The generator is in sleep mode.	▶ Apply a load to the generator by connecting a second power consumer (e.g. worklight). Switch the tool off and then on again.
	The detachable supply cord is not fitted correctly.	▶ Fit the detachable supply cord to the power tool correctly.
The service indicator lights red.	The tool is faulty or servicing is due.	▶ Have the product repaired only by Hilti Service .
The service indicator blinks red.	The voltage provided by the electric supply is too high.	▶ Use a different power outlet. Check the electric supply.
	The overheating prevention cut-out has been activated.	▶ Allow the tool to cool down. Clean the air vents. Running under no load is still possible.

Trouble or fault	Possible cause	Action to be taken
No hammering action.	The power tool is too cold.	► Bring the tip of the accessory tool into contact with the working surface, switch the power tool on and allow it to run. If necessary, repeat the procedure until the hammering mechanism begins to operate.
The breaker doesn't start or cuts out during operation.	The extension cord is too long or its gauge is inadequate.	► Use an extension cord of an approved length and / or of adequate gauge.

9 Disposal

 Most of the materials from which **Hilti** tools and appliances are manufactured can be recycled. The materials must be correctly separated before they can be recycled. In many countries, your old tools, machines or appliances can be returned to **Hilti** for recycling. Ask **Hilti** Service or your Hilti representative for further information.



-
- Disposal of electric tools or appliances together with household waste is not permissible.
-

10 China RoHS (guideline on restriction of the use of dangerous substances)

The following link takes you to the table of dangerous substances: qr.hilti.com/r4783.
You will find a link to the RoHS table, in the form of a QR code, at the end of this document.

11 Manufacturer's warranty

- Please contact your local **Hilti** representative if you have questions about the warranty conditions.



Hilti Aktiengesellschaft
Feldkircherstraße 100
9494 Schaan | Liechtenstein

TE 3000-AVR (02)

[2009]

2004/108/EG
2014/30/EU
2000/14/EG
2006/66/EU
2006/42/EG
2011/65/EU
2000/14/EG-Anhang VI

EN ISO 12100
EN 60745-1
EN 60745-2-6



Measured 105 dB
Guaranteed 108 dB



TÜV Nord CERT GmbH
Am TÜV 1 | DE 30519 Hannover

Paolo Luccini
Head of BA Quality and Process Management
BA Electric Tools & Accessories

Schaan, 05/2015

Tassilo Deinzer
Executive Vice President
BU Power Tools & Accessories





Hilti Corporation

LI-9494 Schaan

Tel.: +423/234 21 11

Fax: +423/234 29 65

www.hilti.com

Hilti = registered trademark of Hilti Corp., Schaan



20170510