

HILTI

Anchor Fastening Technology Manual



Hilti
Screw anchor

Stainless steel
HUS-HR
HUS-CR

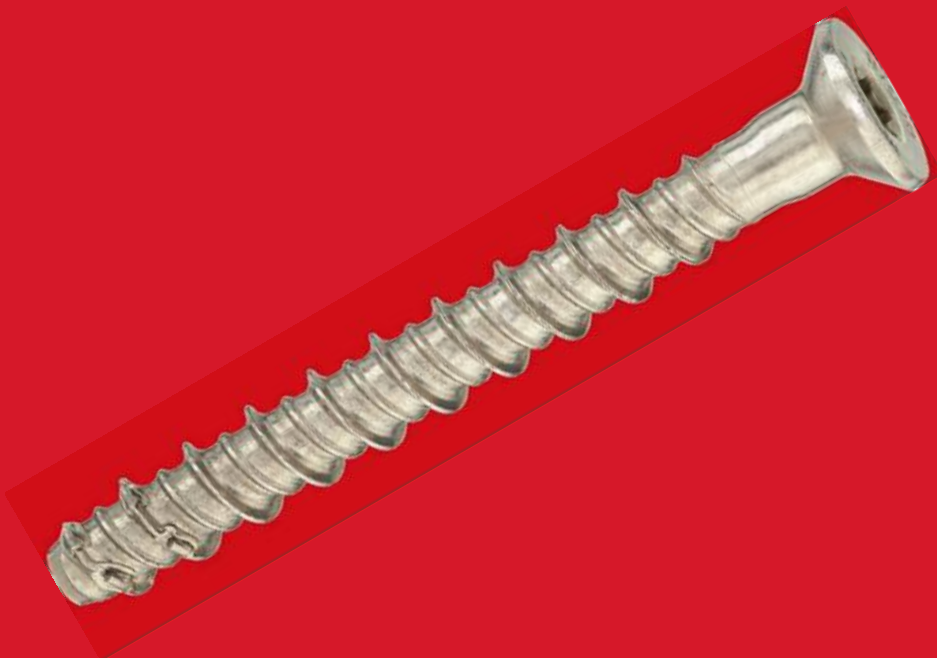
Size 6 – 14



HUS-HR, CR Screw anchor, stainless steel

	Anchor version	Benefits
	HUS-HR 6 / 8 / 10 / 14 Stainless steel concrete Screw with hexagonal head	- High productivity – less drilling and fewer operations than with conventional anchors
	HUS-CR 10 Stainless steel concrete screw with countersunk head	- ETA approval for cracked and non-cracked concrete - Seismic approval ETA C1 - Small edge and spacing distances



Concrete



Tensile
zone

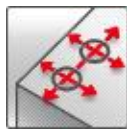

Small edge
distance
and spacing

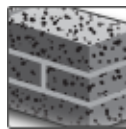

Solid brick

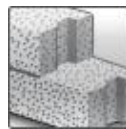

Autoclaved
aerated
concrete



Fire
resistance

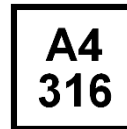

Corrosion
Resistance



Seismic



European
Technical
Approval



CE
conformity



Sprinkler
approved



PROFIS
Anchor
design
software

Approvals / certificates

Description	Authority / Laboratory	No, / date of issue
European technical approval ^{a)}	DIBt, Berlin	ETA-08/0307 / 2014-04-29
Fire test report	DIBt, Berlin	ETA-08/0307 / 2014-04-29
Fire test report ZTV – Tunnel (EBA)	MFPA, Leipzig	PB III / 08-354 / 2008-11-27

a) Data for HUS-HR with standard and reduced embedment depth is given in this section according ETA-08/0307 issue 2014-04-29,

Basic loading data

All data in this section applies to

- Correct setting (See setting instruction)
- No edge distance and spacing influence
- Concrete as specified in the table
- Steel failure
- Minimum base material thickness
- Concrete C 20/25, $f_{ck,cube} = 25 \text{ N/mm}^2$

For details see Simplified design method

Mean ultimate resistance

		Non-cracked concrete				Cracked concrete			
Anchor size		6	8	10	14	6	8	10	14
Type	HUS	HR	HR	HR,CR	HR	HR	HR	HR,CR	HR
Extra reduced embedment (Hilti Tech Data)									
h_{nom}	[mm]	30	50	60	-	30	50	60	-
Tensile $N_{Ru,m}$	[kN]	- ^{a)}	12,0	16,0	-	- ^{a)}	6,7	10,0	-
Shear $V_{Ru,m}$	[kN]	- ^{a)}	31,5	41,9	-	- ^{a)}	22,5	30,0	-
Reduced embedment (ETA-08/0307)									
h_{nom}	[mm]	-	60	70	70	-	60	70	70
Tensile $N_{Ru,m}$	[kN]	-	16,0	21,3	25,2	-	8,0	12,0	16,0
Shear $V_{Ru,m}$	[kN]	-	34,7	44,0	50,4	-	30,9	38,1	36,0
Standard embedment (ETA-08/0307)									
h_{nom}	[mm]	55	80	90	110	55	80	90	110
Tensile $N_{Ru,m}$	[kN]	12,0	21,3	33,3	53,6	6,7	16,0	21,3	33,3
Shear $V_{Ru,m}$	[kN]	22,7	34,7	44,0	102,7	21,7	34,7	44,0	76,6

a) Please refer to resistance table in all load directions for multiple use fastenings in section HUS 6 screw anchor for redundant fastening,

Characteristic resistance

		Non-cracked concrete				Cracked concrete			
Anchor size		6	8	10	14	6	8	10	14
Type	HUS	HR	HR	HR,CR	HR	HR	HR	HR,CR	HR
Extra reduced embedment (Hilti Tech Data)									
h_{nom}	[mm]	30	50	60	-	30	50	60	-
Tensile N_{Rk}	[kN]	- ^{a)}	9,0	12,0	-	- ^{a)}	5,0	7,5	-
Shear V_{Rk}	[kN]	- ^{a)}	23,6	31,4	-	- ^{a)}	16,9	22,5	-
Reduced embedment (ETA-08/0307)									
h_{nom}	[mm]	-	60	70	70	-	60	70	70
Tensile N_{Rk}	[kN]	-	12,0	16,0	18,9	-	6,0	9,0	12,0
Shear V_{Rk}	[kN]	-	26,0	33,0	37,8	-	23,2	28,6	27,0
Standard embedment (ETA-08/0307)									
h_{nom}	[mm]	55	80	90	110	55	80	90	110
Tensile N_{Rk}	[kN]	9,0	16,0	25,0	40,2	5,0	12,0	16,0	25,0
Shear V_{Rk}	[kN]	17,0	26,0	33,0	77,0	16,3	26,0	33,0	57,4

a) Please refer to resistance table in all load directions for multiple use fastenings in section HUS 6 screw anchor for redundant fastening,

Design resistance

		Non-cracked concrete				Cracked concrete			
Anchor size		6	8	10	14	6	8	10	14
Type	HUS	HR	HR	HR,CR	HR	HR	HR	HR,CR	HR
Extra reduced embedment (Hilti Tech Data)									
h_{nom}	[mm]	30	50	60	-	30	50	60	-
Tensile N_{Rd}	[kN]	- ^{a)}	5,0	6,7	-	- ^{a)}	2,8	4,2	-
Shear V_{Rd}	[kN]	- ^{a)}	15,7	21,0	-	- ^{a)}	11,2	15,0	-

Reduced embedment (ETA-08/0307)									
h_{nom}	[mm]	-	60	70	70	-	60	70	70
Tensile N_{Rd}	[kN]	-	6,7	8,9	10,5	-	3,3	5,0	6,7
Shear V_{Rd}	[kN]	-	17,3	22,0	25,2	-	15,5	19,0	18,0
Standard embedment (ETA-08/0307)									
h_{nom}	[mm]	55	80	90	110	55	80	90	110
Tensile N_{Rd}	[kN]	4,3	8,9	13,9	22,3	2,4	6,7	8,9	13,9
Shear V_{Rd}	[kN]	11,3	17,3	22,0	51,3	10,9	17,3	22,0	38,3

a) Please refer to resistance table in all load directions for multiple use fastenings in section HUS 6 screw anchor for redundant fastening,

Recommended loads

		Non-cracked concrete				Cracked concrete			
Anchor size		6	8	10	14	6	8	10	14
Type	HUS	HR	HR	HR,CR	HR	HR	HR	HR,CR	HR
Extra reduced embedment (Hilti Tech Data)									
h_{nom}	[mm]	30	50	60	-	30	50	60	-
Tensile $N_{rec}^{a)}$	[kN]	- ^{b)}	3,6	4,8	-	- ^{b)}	2,0	3,0	-
Shear $V_{rec}^{a)}$	[kN]	- ^{b)}	11,2	15,0	-	- ^{b)}	8,0	10,7	-
Reduced embedment (ETA-08/0307)									
h_{nom}	[mm]	-	60	70	70	-	60	70	70
Tensile $N_{rec}^{a)}$	[kN]	-	4,8	6,3	7,5	-	2,4	3,6	4,8
Shear $V_{rec}^{a)}$	[kN]	-	12,4	15,7	18,0	-	11,0	13,6	12,9
Standard embedment (ETA-08/0307)									
h_{nom}	[mm]	55	80	90	110	55	80	90	110
Tensile $N_{rec}^{a)}$	[kN]	3,1	6,3	9,9	16,0	1,7	4,8	6,3	9,9
Shear $V_{rec}^{a)}$	[kN]	8,1	12,4	15,7	36,7	7,8	12,4	15,7	27,3

a) With overall partial safety factor for action $\gamma = 1,4$, The partial safety factors for action depend on the type of loading and shall be taken from national regulations,

b) Please refer to resistance table in all load directions for multiple use fastenings in section HUS 6 screw anchor for redundant fastening,

Materials

Mechanical properties

Anchor size	6	8	10	14
Type	HUS-HR	HUS-HR	HUS-HR,CR	HUS-HR
Nominal tensile strength f_{uk} [N/mm ²]	1050	870	950	690
Nominal yield strength f_{yk} [N/mm ²]	900	745	815	590
Stressed cross-section A_s [mm ²]	22,9	39,0	55,4	143,1
Moment of resistance W [mm ³]	15	34	58	255
Design bending resistance $M_{Rd,s}$ [Nm]	19	36	66	193

Part	Material
Stainless steel hexagonal head concrete screw	Stainless steel (grade A4)

Anchor dimensions

Dimensions

Anchor version	d_s [mm]	d_k [mm]	A_s [mm ²]
HUS-HR 6	7,6	5,4	22,9
HUS-HR 8	10,1	7,05	39,0
HUS-HR 10	12,3	8,40	55,4
HUS-CR 10	12,3	8,40	55,4
HUS-HR 14	16,6	12,6	143,1

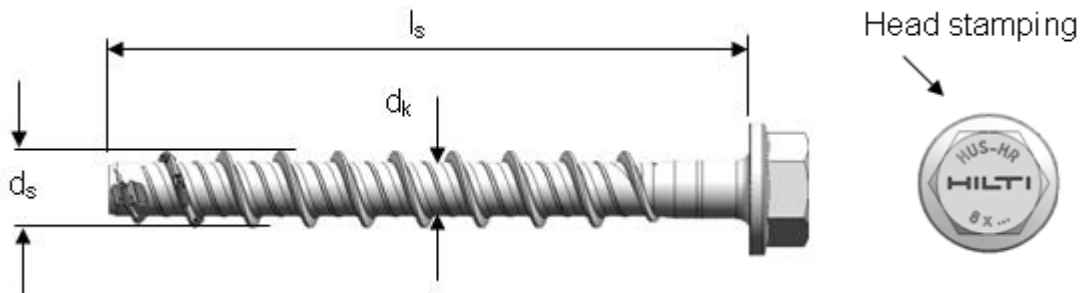

Screw length and thickness of fixture for HUS-HR (hex head)

Anchor size	HUS HR	6		8			10			14	
		h_{nom} 30	h_{nom} 55	h_{nom} 50	h_{nom} 60	h_{nom} 80	h_{nom} 60	h_{nom} 70	h_{nom} 90	h_{nom} 70	h_{nom} 110
Nominal anchorage depth [mm]		Thickness of fixture [mm]									
Length of anchor [mm]		t_{fix1}	t_{fix2}	t_{fix1}	t_{fix2}	t_{fix3}	t_{fix1}	t_{fix2}	t_{fix3}	t_{fix1}	t_{fix2}
35		5	-	-	-	-	-	-	-	-	-
45		15	-	-	-	-	-	-	-	-	-
60		30	5	-	-	-	-	-	-	-	-
65		-	-	15	5	-	5	-	-	-	-
70		40	15	-	-	-	-	-	-	-	-
75		-	-	25	15	-	15	5	-	-	-
80		-	-	-	-	-	-	-	-	10	-
85		-	-	35	25	5	25	15	-	-	-
95		-	-	45	35	15	35	25	5	-	-
105		-	-	55	45	25	45	35	15	-	-
115		-	-	-	-	-	55	45	25	-	-
120		-	-	-	-	-	-	-	-	50	10
130		-	-	-	-	-	70	60	40	-	-
135		-	-	-	-	-	-	-	-	65	25

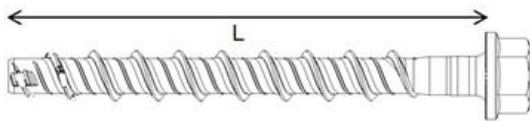

Screw length and thickness of fixture for HUS-CR (countersunk head)

Anchor size	HUS HR	10		
		h_{nom} 60	h_{nom} 70	h_{nom} 90
Nominal anchorage depth [mm]		Thickness of fixture [mm]		
Length of anchor [mm]		t_{fix1}	t_{fix2}	t_{fix3}
75		15	-	-
85		25	15	-
105		45	35	15

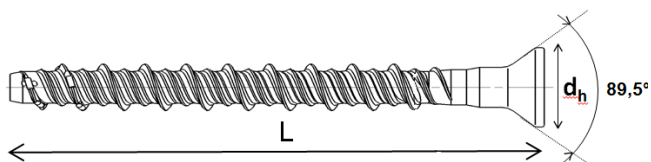

Setting

Recommended installation equipment

Anchor size	HUS	6	8	10	14
Rotary hammer		Hilti TE 2 – TE 30	Hilti TE 2 – TE 30	Hilti TE 2 – TE 30	Hilti TE 2 – TE 30
drill bit		TE-C3X 6/17	TE-C3X 8/17	TE-C3X 10/22	TE-C3X 14/22
Socket wrench insert		S-NSD 13 ½ (L)	S-NSD 13 ½ (L)	S-NSD 15 ½ (L)	S-NSD 21 ½
Torx (CR type only)		-	-	S-SY TX50	-
Impact screw driver		Hilti SIW 14-A, 22-A	Hilti SIW 22 T-A		

Setting instruction

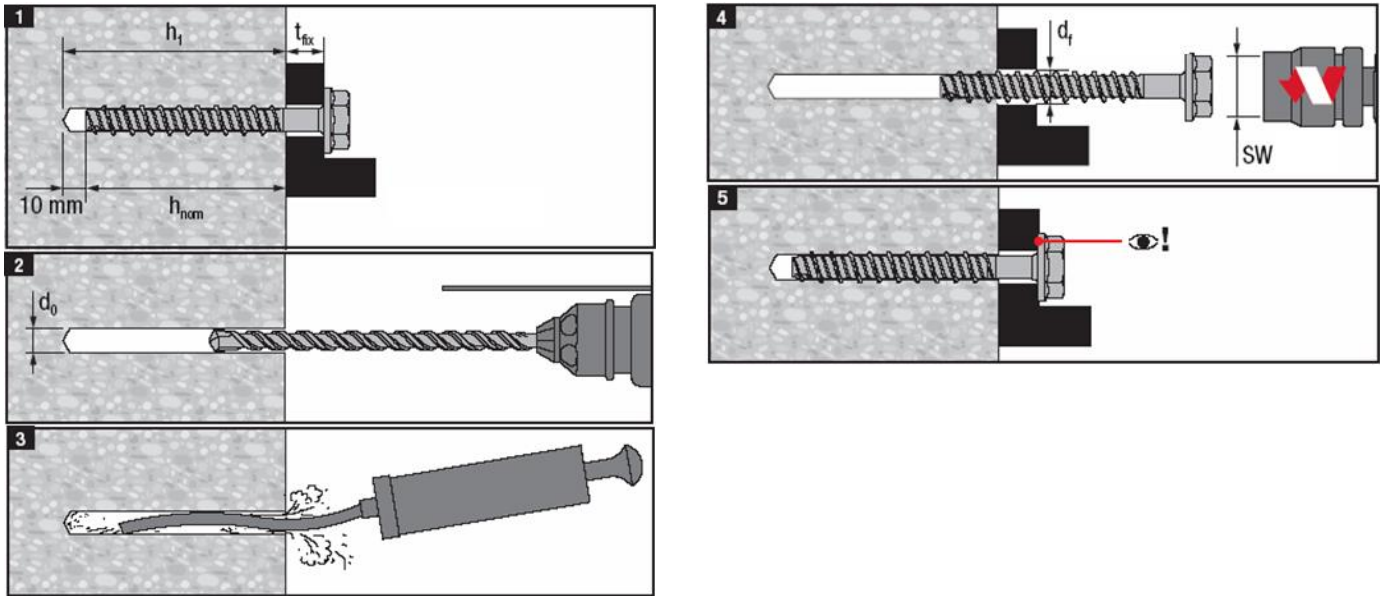

For detailed information on installation see instruction for use given with the package of the product,

Setting details: depth of drill hole h_1 and effective anchorage depth h_{ef}

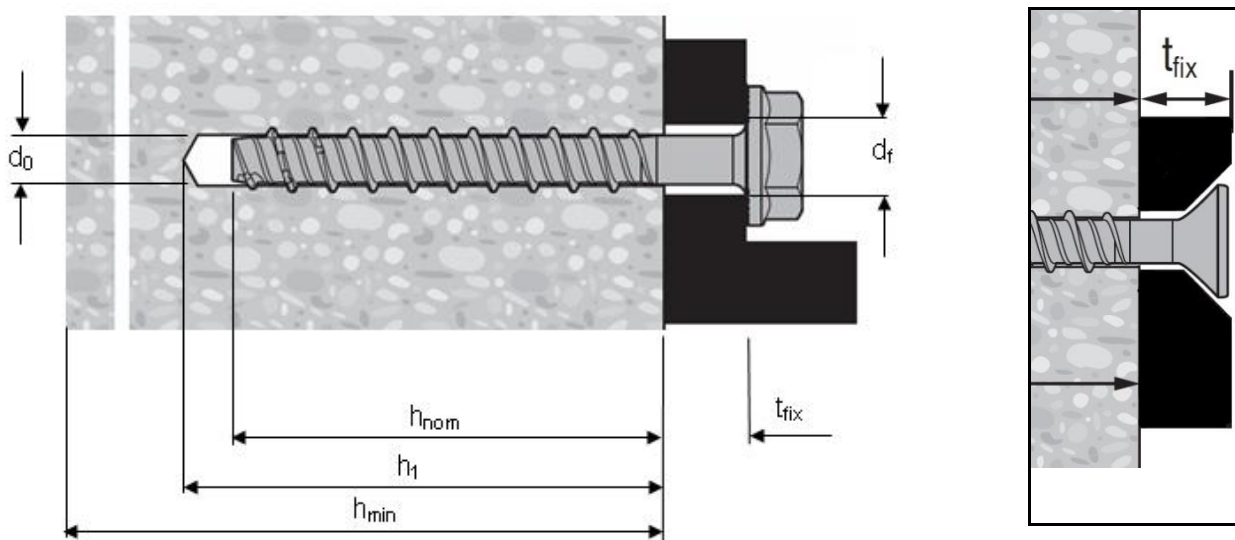

Setting details

Anchor version			6		8			10			14		
Type	HUS		HR		HR			HR, CR ^{a)}			HR		
Nominal embedment depth	h_{nom}	[mm]	30	55	50	60	80	60	70	90	70	110	
Nominal diameter of drill bit	d_o	[mm]	6		8			10			14		
Cutting diameter of drill bit	$d_{cut} \leq$	[mm]	6,4		8,45			10,45			14,5		
Depth of drill hole	$h_1 \geq$	[mm]	40	65	60	70	90	70	80	100	80	120	
Diameter of countersunk head	d_h	[mm]	-		-			21			-		
Diameter of clearance hole in the fixture	$d_f \leq$	[mm]	9		12			14			18		
Effective anchorage depth	h_{ef}	[mm]	23	45	38	47	64	46	54	71	52	86	
Max, installation torque	Concrete	T_{inst}	[Nm]	20	- a)	35	- a)	- a)	45 c)			65	
	Solid m, Mz 12	T_{inst}	[Nm]	- b)	10	- b)	16	16	-	20	20	- b)	- b)
	Solid m, KS 12	T_{inst}	[Nm]	- b)	10	- b)	16	16	-	20	20	- b)	- b)
	Aerated conc,	T_{inst}	[Nm]	- b)	4	- b)	8	8	-	10	10	- b)	- b)

- a) Hilti recommends machine setting only in concrete
- b) Hilti does not recommend this setting process for this application,
- c) Intallation torque refer to HUS-HR only

Base material thickness, anchor spacing and edge distance

Anchor size			6		8			10			14	
Type			HUS-HR		HUS-HR			HUS-HR, CR			HUS-HR	
Nominal embedment depth	h_{nom}	[mm]	30	55	50	60	80	60	70	90	70	110
Minimum base material thickness non-cracked concrete	h_{min}	[mm]	100	100	100	100	120	120	120	140	140	160
Minimum spacing	s_{min}	[mm]	35	35	45	45	50	50	50	50	50	60
Minimum edge distance	c_{min}	[mm]	35	35	45	45	50	50	50	50	50	60
Critical spacing for concrete cone and splitting failure	$s_{cr,N} = s_{cr,sp}$	[mm]	69	135	114	141	192	166	194	256	187	310
Critical edge distance for concrete cone and splitting failure	$c_{cr,N} = c_{cr,sp}$	[mm]	35	68	57	71	96	83	97	128	94	155

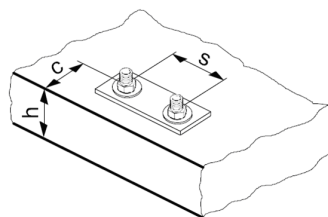

For spacing (edge distance) smaller than critical spacing (critical edge distance) the design loads have to be reduced (see system design resistance),

Critical spacing and critical edge distance for splitting failure apply only for non-cracked concrete, For cracked concrete only the critical spacing and critical edge distance for concrete cone failure are decisive,

Simplified design method

Simplified version of the design method according ETAG 001, Annex C, Design resistance according data given in ETA-08/0307 issue 2011,01,21,

- Influence of concrete strength
- Influence of edge distance
- Influence of spacing
- Valid for a group of two anchors, (The method may also be applied for anchor groups with more than two anchors or more than one edge, The influencing factors must then be considered for each edge distance and spacing, The calculated design loads are then on the same side: They will be lower than the exact values according ETAG 001, Annex C, To avoid this, it is recommended to use the anchor design software PROFIS anchor)

The design method is based on the following simplification:

- No different loads are acting on individual anchors (no eccentricity)

The values are valid for one anchor (single point fastening), multiple use applications are not part of this design method,

For more complex fastening applications please use the anchor design software PROFIS Anchor,

TENSION loading

The design tensile resistance is the lower value of

- Steel resistance: $N_{Rd,s}$
- Concrete pull-out resistance: $N_{Rd,p} = N_{Rd,p}^0 \cdot f_B$
- Concrete cone resistance: $N_{Rd,c} = N_{Rd,c}^0 \cdot f_B \cdot f_{1,N} \cdot f_{2,N} \cdot f_{3,N} \cdot f_{re,N}$
- Concrete splitting resistance (only non-cracked concrete): $N_{Rd,sp} = N_{Rd,c}^0 \cdot f_B \cdot f_{1,sp} \cdot f_{2,sp} \cdot f_{3,sp} \cdot f_{re,N}$

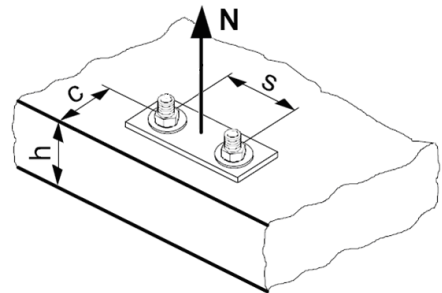

Basic design tensile resistance

Design steel resistance $N_{Rd,s}$

Anchor size		6	8	10	14
Type		HUS-HR	HUS-HR	HUS-HR, CR	HUS-HR
$N_{Rd,s}$	[kN]	17,0	24,3	37,6	73,0

Design pull-out resistance $N_{Rd,p} = N_{Rd,p}^0 \cdot f_B$

Anchor size		Non-cracked concrete				Cracked concrete			
		6	8	10	14	6	8	10	14
Extra reduced embedment (Hilti Tech Data)									
h_{nom}	[mm]	30	50	60	-	30	50	60	-
Tensile N_{Rd}	[kN]	-	5,0	6,7	-	-	2,8	4,2	-
Reduced embedment									
h_{nom}	[mm]	-	60	70	70	-	60	70	70
Tensile N_{Rd}	[kN]	-	6,7	8,9	10,5	-	3,3	5,0	6,7
Standard embedment									
h_{nom}	[mm]	55	80	90	110	55	80	90	110
Tensile N_{Rd}	[kN]	4,3	8,9	13,9	22,3	2,4	6,7	8,9	13,9

Design concrete cone $N_{Rd,c} = N_{Rd,c}^0 \cdot f_B \cdot f_{1,N} \cdot f_{2,N} \cdot f_{3,N} \cdot f_{re,N}$

Design splitting resistance* $N_{Rd,sp} = N_{Rd,c}^0 \cdot f_B \cdot f_{1,sp} \cdot f_{2,sp} \cdot f_{3,sp} \cdot f_{re,N}$

		Non-cracked concrete				Cracked concrete			
Anchor size		6	8	10	14	6	8	10	14
Type	HUS	HR	HR	HR,CR	HR	HR	HR	HR,CR	HR
Extra reduced embedment (Hilti Tech Data)									
h_{nom}	[mm]	30	50	60	-	30	50	60	-
$N_{Rd,c}^0$	[kN]	-	6,6	8,7	-	-	4,7	6,2	-
Reduced embedment									
h_{nom}	[mm]	-	60	70	70	-	60	70	70
$N_{Rd,c}^0$	[kN]	-	9,0	11,1	10,5	-	6,4	7,9	7,5
Standard embedment									
h_{nom}	[mm]	55	80	90	110	55	80	90	110
$N_{Rd,c}^0$	[kN]	7,2	14,3	16,8	22,3	5,2	10,2	12,0	16,0

a) Splitting resistance must only be considered for non-cracked concrete

ETA: Data according ETA-08/0307 issue 2008-12-12 Hilti: Additional Hilti technical data

Influencing factors

Influence of concrete strength

Concrete strength designation (ENV 206)	C 20/25	C 25/30	C 30/37	C 35/45	C 40/50	C 45/55	C 50/60
$f_B = (f_{ck,cube}/25N/mm^2)^{0,5}$ ^{a)}	1	1,1	1,22	1,34	1,41	1,48	1,55

a) $f_{ck,cube}$ = concrete compressive strength, measured on cubes with 150 mm side length

Influence of edge distance ^{a)}

$c/c_{cr,N}$	0,1	0,2	0,3	0,4	0,5	0,6	0,7	0,8	0,9	1
$c/c_{cr,sp}$										
$f_{1,N} = 0,7 + 0,3 \cdot c/c_{cr,N} \leq 1$	0,73	0,76	0,79	0,82	0,85	0,88	0,91	0,94	0,97	1
$f_{1,sp} = 0,7 + 0,3 \cdot c/c_{cr,sp} \leq 1$										
$f_{2,N} = 0,5 \cdot (1 + c/c_{cr,N}) \leq 1$	0,55	0,60	0,65	0,70	0,75	0,80	0,85	0,90	0,95	1
$f_{2,sp} = 0,5 \cdot (1 + c/c_{cr,sp}) \leq 1$										

a) The edge distance shall not be smaller than the minimum edge distance c_{min} given in the table with the setting details, These influencing factors must be considered for every edge distance,

Influence of anchor spacing ^{a)}

$s/s_{cr,N}$	0,1	0,2	0,3	0,4	0,5	0,6	0,7	0,8	0,9	1
$s/s_{cr,sp}$										
$f_{3,N} = 0,5 \cdot (1 + s/s_{cr,N}) \leq 1$	0,55	0,60	0,65	0,70	0,75	0,80	0,85	0,90	0,95	1
$f_{3,sp} = 0,5 \cdot (1 + s/s_{cr,sp}) \leq 1$										

a) The anchor spacing shall not be smaller than the minimum anchor spacing s_{min} given in the table with the setting details, This influencing factor must be considered for every anchor spacing,

Influence of base material thickness

h/h_{ef}	2,0	2,2	2,4	2,6	2,8	3,0	3,2	3,4	3,6	$\geq 3,68$
$f_{h,sp} = [h/(2 \cdot h_{ef})]^{2/3}$	1	1,07	1,13	1,19	1,25	1,31	1,37	1,42	1,48	1,5

Influence of reinforcement

Anchor size		6		8			10			14	
Type	HUS	HR		HR			HR, CR			HR	
h_{nom}	[mm]	30	55	50	60	80	60	70	90	70	110
h_{ef}	[mm]	23	45	38	47	64	46	54	71	52	86
$f_{re,N} = 0,5 + h_{ef}/200mm \leq 1$		0,62	0,73	0,69	0,74	0,82	0,73	0,77	0,86	0,76	0,93

- a) This factor applies only for dense reinforcement, If in the area of anchorage there is reinforcement with a spacing ≥ 150 mm (any diameter) or with a diameter ≤ 10 mm and a spacing ≥ 100 mm, then a factor $f_{re,N} = 1$ may be applied,

SHEAR loading

The design shear resistance is the lower value of

- Steel resistance: $V_{Rd,s}$
- Concrete pryout resistance: $V_{Rd,cp} = k \cdot N_{Rd,c}$
- Concrete edge resistance: $V_{Rd,c} = V_{Rd,c}^0 \cdot f_B \cdot f_{\beta} \cdot f_h \cdot f_4 \cdot f_{hef} \cdot f_c$

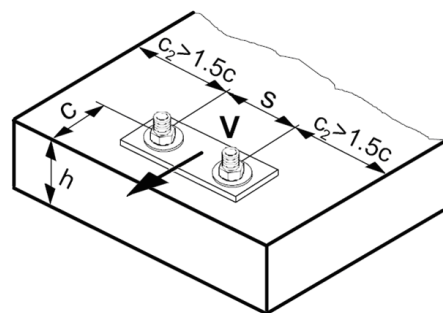

Basic design shear resistance

Design steel resistance $V_{Rd,s}$

Anchor size			6	8	10	14
Type	HUS		HR	HR	HR, CR	HR
Extra reduced embedment	$V_{Rd,s}$	[kN]	11,3	17,3	22,0	-
Reduced embedment	$V_{Rd,s}$	[kN]	-	17,3	22,0	36,7
Standard embedment	$V_{Rd,s}$	[kN]	11,3	17,3	22,0	51,3

Design concrete pryout resistance $V_{Rd,cp} = k \cdot N_{Rd,c}$ ^{a)}

Anchor size		6		8			10			14	
Type	HUS	HR		HR			HR, CR			HR	
h_{nom}	[mm]	30	55	50	60	80	60	70	90	70	110
k		1,0	1,5	2,0							

- a) $N_{Rd,c}$: Design concrete cone resistance

Design concrete edge resistance $V_{Rd,c} = V_{Rd,c}^0 \cdot f_B \cdot f_\beta \cdot f_h \cdot f_4 \cdot f_{hef} \cdot f_c$

	Non-cracked concrete				Cracked concrete			
Anchor size	6	8	10	14	6	8	10	14
Type HUS	HR	HR	HR,CR	HR	HR	HR	HR,CR	HR
Extra reduced embedment (Hilti Tech Data)								
h_{nom} [mm]	30	50	60	-	30	50	60	-
$V_{Rd,c}^0$ [kN]	-	5,9	8,6	-	-	4,2	6,1	-
Reduced embedment								
h_{nom} [mm]	-	60	70	70	-	60	70	70
$V_{Rd,c}^0$ [kN]	-	5,9	8,6	15	-	4,2	6,1	10,6
Standard embedment								
h_{nom} [mm]	55	80	90	110	55	80	90	110
$V_{Rd,c}^0$ [kN]	3,6	5,9	8,6	15,1	2,6	4,2	6,1	10,7

Influencing factors

Influence of concrete strength

Concrete strength designation (ENV 206)	C 20/25	C 25/30	C 30/37	C 35/45	C 40/50	C 45/55	C 50/60
$f_B = (f_{ck,cube}/25N/mm^2)^{0,5}$ a)	1	1,1	1,22	1,34	1,41	1,48	1,55

a) $f_{ck,cube}$ = concrete compressive strength, measured on cubes with 150 mm side length

Influence of angle between load applied and the direction perpendicular to the free edge

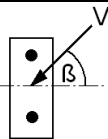
Angle β	0°	10°	20°	30°	40°	50°	60°	70°	80°	≥ 90°
$f_\beta = \frac{1}{\sqrt{(\cos \alpha_v)^2 + \left(\frac{\sin \alpha_v}{2,5}\right)^2}}$ 	1	1,01	1,05	1,13	1,24	1,40	1,64	1,97	2,32	2,50

Influence of base material thickness

h/c	0,15	0,3	0,45	0,6	0,75	0,9	1,05	1,2	1,35	≥ 1,5
$f_h = \{h/(1,5 \cdot c)\}^{1/2} \leq 1$	0,32	0,45	0,55	0,63	0,71	0,77	0,84	0,89	0,95	1,00

Influence of anchor spacing and edge distance ^{a)} for concrete edge resistance: f_4

c/h_{ef}	Single anchor	Group of two anchors s/h_{ef}														
		0,75	1,50	2,25	3,00	3,75	4,50	5,25	6,00	6,75	7,50	8,25	9,00	9,75	10,50	11,25
0,50	0,35	0,27	0,35	0,35	0,35	0,35	0,35	0,35	0,35	0,35	0,35	0,35	0,35	0,35	0,35	0,35
0,75	0,65	0,43	0,54	0,65	0,65	0,65	0,65	0,65	0,65	0,65	0,65	0,65	0,65	0,65	0,65	0,65
1,00	1,00	0,63	0,75	0,88	1,00	1,00	1,00	1,00	1,00	1,00	1,00	1,00	1,00	1,00	1,00	1,00
1,25	1,40	0,84	0,98	1,12	1,26	1,40	1,40	1,40	1,40	1,40	1,40	1,40	1,40	1,40	1,40	1,40
1,50	1,84	1,07	1,22	1,38	1,53	1,68	1,84	1,84	1,84	1,84	1,84	1,84	1,84	1,84	1,84	1,84
1,75	2,32	1,32	1,49	1,65	1,82	1,98	2,15	2,32	2,32	2,32	2,32	2,32	2,32	2,32	2,32	2,32
2,00	2,83	1,59	1,77	1,94	2,12	2,30	2,47	2,65	2,83	2,83	2,83	2,83	2,83	2,83	2,83	2,83
2,25	3,38	1,88	2,06	2,25	2,44	2,63	2,81	3,00	3,19	3,38	3,38	3,38	3,38	3,38	3,38	3,38
2,50	3,95	2,17	2,37	2,57	2,77	2,96	3,16	3,36	3,56	3,76	3,95	3,95	3,95	3,95	3,95	3,95
2,75	4,56	2,49	2,69	2,90	3,11	3,32	3,52	3,73	3,94	4,15	4,35	4,56	4,56	4,56	4,56	4,56
3,00	5,20	2,81	3,03	3,25	3,46	3,68	3,90	4,11	4,33	4,55	4,76	4,98	5,20	5,20	5,20	5,20
3,25	5,86	3,15	3,38	3,61	3,83	4,06	4,28	4,51	4,73	4,96	5,18	5,41	5,63	5,86	5,86	5,86
3,50	6,55	3,51	3,74	3,98	4,21	4,44	4,68	4,91	5,14	5,38	5,61	5,85	6,08	6,31	6,55	6,55
3,75	7,26	3,87	4,12	4,36	4,60	4,84	5,08	5,33	5,57	5,81	6,05	6,29	6,54	6,78	7,02	7,26
4,00	8,00	4,25	4,50	4,75	5,00	5,25	5,50	5,75	6,00	6,25	6,50	6,75	7,00	7,25	7,50	7,75
4,25	8,76	4,64	4,90	5,15	5,41	5,67	5,93	6,18	6,44	6,70	6,96	7,22	7,47	7,73	7,99	8,25
4,50	9,55	5,04	5,30	5,57	5,83	6,10	6,36	6,63	6,89	7,16	7,42	7,69	7,95	8,22	8,49	8,75
4,75	10,35	5,45	5,72	5,99	6,27	6,54	6,81	7,08	7,36	7,63	7,90	8,17	8,45	8,72	8,99	9,26
5,00	11,18	5,87	6,15	6,43	6,71	6,99	7,27	7,55	7,83	8,11	8,39	8,66	8,94	9,22	9,50	9,78
5,25	12,03	6,30	6,59	6,87	7,16	7,45	7,73	8,02	8,31	8,59	8,88	9,17	9,45	9,74	10,02	10,31
5,50	12,90	6,74	7,04	7,33	7,62	7,92	8,21	8,50	8,79	9,09	9,38	9,67	9,97	10,26	10,55	10,85

a) The anchor spacing and the edge distance shall not be smaller than the minimum anchor spacing s_{min} and the minimum edge distance c_{min} ,

Influence of embedment depth

Anchor size		6		8			10			14	
Type	HUS	HR		HR			HR, CR			HR	
h_{nom}	[mm]	30	55	50	60	80	60	70	90	70	110
$f_{hef} = 0,05 \cdot (h_{ef} / d)^{1,68}$		-	1,48	0,69	0,98	1,64	0,65	0,85	1,35	0,45	1,06

Influence of edge distance ^{a)}

c/d	4	6	8	10	15	20	30	40
$f_c = (d / c)^{0,19}$	0,77	0,71	0,67	0,65	0,60	0,57	0,52	0,50

a) The edge distance shall not be smaller than the minimum edge distance c_{min} ,

Combined TENSION and SHEAR loading

For combined tension and shear loading see section "Anchor Design",

Precalculated values

Design resistance calculated according ETAG 001, Annex C and data given in ETA-08/0307, issue 2011,01,21, All data applies to concrete C 20/25 – $f_{ck,cube} = 25$ N/mm², Hilti technical data for the extra reduced embedment depth is not part of the approval,

Recommended loads can be calculated by dividing the design resistance by an overall partial safety factor for action $\gamma = 1,4$, The partial safety factors for action depend on the type of loading and shall be taken from national regulations,

Design resistance

Single anchor, no edge effects ($c \geq c_{cr}$), shear without lever arm

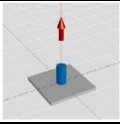
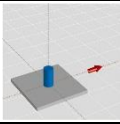
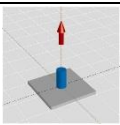
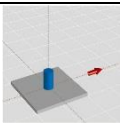
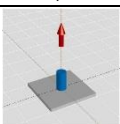
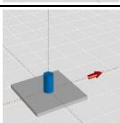
			Non-cracked concrete				Cracked concrete			
Anchor size			6	8	10	14	6	8	10	14
Type	HUS		HR	HR	HR,CR	HR	HR	HR	HR,CR	HR
Extra reduced embedment (Hilti Tech Data)										
h_{nom}	[mm]		30	50	60	-	30	50	60	-
Min, base material thickness h_{min} [mm]			80	100	120	-	80	100	120	-
	Tensile N_{Rd}	[kN]	-	5,0	6,7	-	-	2,8	4,2	-
	Shear V_{Rd}	[kN]	-	15,7	21,0	-	-	11,2	15,0	-
Reduced embedment										
h_{nom}	[mm]		-	60	70	70	-	60	70	70
Min, base material thickness h_{min} [mm]			-	100	120	140	-	100	120	140
	Tensile N_{Rd}	[kN]	-	6,7	8,9	10,5	-	3,3	5,0	6,7
	Shear V_{Rd}	[kN]	-	17,3	22,0	25,2	-	15,5	19,0	18,0
Standard embedment										
h_{nom}	[mm]		55	80	90	110	55	80	90	110
Min, base material thickness h_{min} [mm]			100	120	140	160	100	120	140	160
	Tensile N_{Rd}	[kN]	4,3	8,9	13,9	22,3	2,4	6,7	8,9	13,9
	Shear V_{Rd}	[kN]	11,3	17,3	22,0	51,3	10,9	17,3	22,0	38,3

Single anchor, min, edge distance ($c = c_{min}$), shear without lever arm

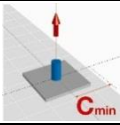
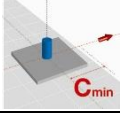
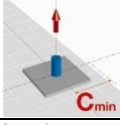
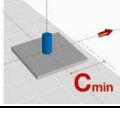
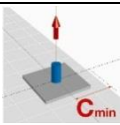
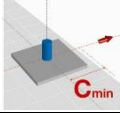
			Non-cracked concrete				Cracked concrete			
Anchor size			6	8	10	14	6	8	10	14
Type	HUS		HR	HR	HR,CR	HR	HR	HR	HR,CR	HR
Extra reduced embedment (Hilti Tech Data)										
h_{nom}	[mm]		30	50	60	-	30	50	60	-
Min, base material thickness h_{min} [mm]			80	100	120	-	80	100	120	-
Min, edge distance c_{min} [mm]			40	45	50	-	40	45	50	-
	Tensile N_{Rd}	[kN]	-	5,0	6,7	-	-	2,8	4,2	-
	Shear V_{Rd}	[kN]	-	3,8	4,7	-	-	2,7	3,3	-
Reduced embedment										
h_{nom}	[mm]		-	60	70	70	-	60	70	70
Min, base material thickness h_{min} [mm]			-	100	120	140	-	100	120	140
Min, edge distance c_{min} [mm]			-	45	50	50	-	45	50	50
	Tensile N_{Rd}	[kN]	-	6,6	8,0	7,7	-	3,3	5,0	4,9
	Shear V_{Rd}	[kN]	-	3,9	4,8	5,0	-	2,8	3,4	3,6
Standard embedment										
h_{nom}	[mm]		55	80	90	110	55	80	90	110
Min, base material thickness h_{min} [mm]			100	120	140	160	100	120	140	160
Min, edge distance c_{min} [mm]			40	50	50	60	40	50	50	60
	Tensile N_{Rd}	[kN]	4,3	8,9	10,4	13,8	2,4	6,7	6,8	9,0
	Shear V_{Rd}	[kN]	3,2	4,8	5,1	7,1	2,2	3,4	3,6	5,0

**Double anchor, no edge effects ($c \geq c_{cr}$), min, spacing ($s = s_{min}$), shear without lever arm
(load values are valid for one anchor)**

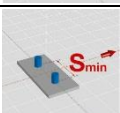
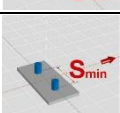
			Non-cracked concrete				Cracked concrete			
Anchor size			6	8	10	14	6	8	10	14
Type	HUS		HR	HR	HR,CR	HR	HR	HR	HR,CR	HR
Extra reduced embedment (Hilti Tech Data)										
h_{nom}	[mm]		30	50	60	-	30	50	60	-
Min, base material thickness h_{min} [mm]			80	100	120	-	80	100	120	-
Min, spacing s_{min} [mm]			40	45	50	-	40	45	50	-
	Tensile N_{Rd}	[kN]	-	4,6	6,0	-	-	3,3	4,3	-
	Shear V_{Rd}	[kN]	-	11,0	14,3	-	-	7,8	10,2	-
Reduced embedment										
h_{nom}	[mm]		-	60	70	70	-	60	70	70
Min, base material thickness h_{min} [mm]			-	100	120	140	-	100	120	140
Min, spacing s_{min} [mm]			-	45	50	50	-	45	50	50
	Tensile N_{Rd}	[kN]	-	6,0	7,3	6,9	-	4,3	5,2	5,0
	Shear V_{Rd}	[kN]	-	14,3	17,5	16,7	-	10,2	12,5	11,9
Standard embedment										
h_{nom}	[mm]		55	80	90	110	55	80	90	110
Min, base material thickness h_{min} [mm]			100	120	140	160	100	120	140	160
Min, spacing s_{min} [mm]			40	50	50	60	40	50	50	60
	Tensile N_{Rd}	[kN]	4,7	9,1	10,4	13,8	3,4	6,5	7,4	9,8
	Shear V_{Rd}	[kN]	9,9	17,3	22,0	33,1	7,0	15,5	17,7	23,6

Fire resistance

Basic loading data for concrete C20/25 – C50/60

All data in this section applies to:

- Correct setting (see setting instruction)
- No edge distance and spacing influence
- Minimum base material thickness

The following technical data are based on: ETA-08/0307 issue 2014-04-29

Characteristic loads under fire exposure

Anchor Size		6	8		10		14		
Type	HUS	HR	HR		HR, CR		HR, CR		
		h_{nom}	h_{nom}	h_{nom}	h_{nom}	h_{nom}	h_{nom}	h_{nom}	
Nominal embedment depth	h_{nom} [mm]	50	60	80	70	90	70	110	
Steel failure for tension and shear load ($F_{Rec,s,fi} = N_{Rec,s,fi} = V_{Rec,s,fi}$)									
Recommended tensile and shear load	R30	$F_{Rec,s,fi}$ [kN]	2,3	4,4	8,8	19,9			
	R60	$F_{Rec,s,fi}$ [kN]	1,6	3,0	5,7	12,8			
	R90	$F_{Rec,s,fi}$ [kN]	0,9	1,5	2,6	5,8			
	R120	$F_{Rec,s,fi}$ [kN]	0,5	0,8	1,1	2,6			
	R30	$M^0_{Rec,s,fi}$ [Nm]	1,9	3,9	9,2	31,2			
	R60	$M^0_{Rec,s,fi}$ [Nm]	1,3	2,6	6,0	20,2			
	R90	$M^0_{Rec,s,fi}$ [Nm]	0,7	1,3	2,7	9,1			
	R120	$M^0_{Rec,s,fi}$ [Nm]	0,4	0,7	1,2	4,0			
Pull out failure									
Recommended resistance	R30 R60 R90	$N_{Rec,p,fi}$ [kN]	0,6	0,7	1,4	1,1	1,9	1,4	3,0
	R120	$N_{Rec,p,fi}$ [kN]	0,5	0,6	1,1	0,9	1,5	1,1	2,4
Concrete cone failure									
Edge distance									
	R30 to R120	$c_{cr,N}$ [mm]	$2h_{ef}$						
Spacing									
	R30 to R120	$s_{cr,N}$ [mm]	$4h_{ef}$						
Concrete pry-out failure									
	R30 to R120	k [-]	1,5	2,0	2,0	2,0			

- a) The recommended loads under fire exposure include a safety factor for resistance under fire exposure $\gamma_{M,fi} = 1,0$ and the partial safety factor for action $\gamma_{F,fi} = 1,0$. The partial safety factors for action shall be taken from national regulations,

Seismic design

Basic loading data for concrete C20/25 – C50/60

All data in this section applies to:

- Seismic design according to TR045

The following technical data are based on: ETA-08/0307 issue 2014-04-30

Anchorage depth range

Anchor size		8	10	14
Type	HUS	HR	HR, CR	HR
Nominal anchorage depth range	h_{nom} [mm]	80	90	110

Tension resistance in case of seismic performance category C1

Anchor size		8	10	14
Type	HUS	HR	HR, CR	HR
Characteristic tension resistance to steel failure				
	$N_{Rk,s,seis}$ [kN]	34,0	52,6	102,2
Partial safety factor	$\gamma_{Ms,seis}$ [-]	1,4		
Characteristic pull-out resistance in cracked concrete C20/25 to C50/60				
	$N_{Rk,p,seis}$ [kN]	7,7	12,5	17,5
Partial safety factor	$\gamma_{Mp,seis}$ [-]	1,8		
Concrete cone resistance and splitting resistance				
Partial safety factor	$\gamma_{Mc,seis} = \gamma_{Msp,seis}$ [-]	1,8		

Displacement under tension load in case of seismic performance category C1 ¹⁾

Anchor size		8	10	14
Type	HUS	HR	HR, CR	HR
Displacement	$\delta_{N,seis}$ [mm]	1,2	1,2	0,4

1) Maximum displacement during cycling (seismic event),

Shear resistance in case of seismic performance category C1 ¹⁾

Anchor size		8	10	14
Type	HUS	HR	HR, CR	HR
Characteristic shear resistance to steel failure				
	$V_{Rk,s,seis}$ [kN]	11,1	17,9	53,9
Partial safety factor	$\gamma_{Ms,seis}$ [-]	1,5		
Concrete pryout resistance and concrete edge resistance				
Partial safety factor	$\gamma_{Mc,seis}$ [-]	1,5		

1) Reduction factor $\alpha_{gap} = 1,0$ when using the Hilti Dynamic Set

Displacement under tension load in case of seismic performance category C1 ¹⁾

Anchor size		8	10	14
Type	HUS	HR	HR, CR	HR
Displacement	$\delta_{V,seis}$ [mm]	4,8	5,3	7,6



1) Maximum displacement during cycling (seismic event)

Basic loading data for single anchor in solid masonry units

All data in this section applies to

- Load values valid for holes drilled with TE rotary hammers in hammering mod
- Correct anchor setting (see instruction for use, setting details)
- The core / material ratio may not exceed 15% of a bed joint area,
- The brim area around holes must be at least 70mm
- Edge distances, spacing and other influences, see below

Recommended loads

Base material		Anchor size Type	Hilti		
			6 HUS-HR	8 HUS-HR	10 HUS-HR, CR
Germany, Austria, Switzerland		h_{nom} [mm]	55	60	70
Solid clay brick Mz12/2,0 	DIN 105/ EN 771-1 $f_b^{a)} \geq 12 \text{ N/mm}^2$	Tensile N_{rec} [kN]	0,9	1,0	1,1
		Shear V_{rec} [kN]	1,4	2,0	2,3
Solid sand-lime brick KS 12/2,0 	DIN 106/ EN 771-2 $f_b^{a)} \geq 12 \text{ N/mm}^2$	Tensile N_{rec} [kN]	0,6	0,6	1,0
		Shear V_{rec} [kN]	0,9	1,1	1,7
Aerated concrete PPW 6-0,4 	DIN 4165/ EN 771-4 $f_b^{a)} \geq 6 \text{ N/mm}^2$	Tensile N_{rec} [kN]	0,2	0,2	0,4
		Shear V_{rec} [kN]	0,4	0,4	0,9

a) f_b = brick strength

Permissible anchor location in brick and block walls

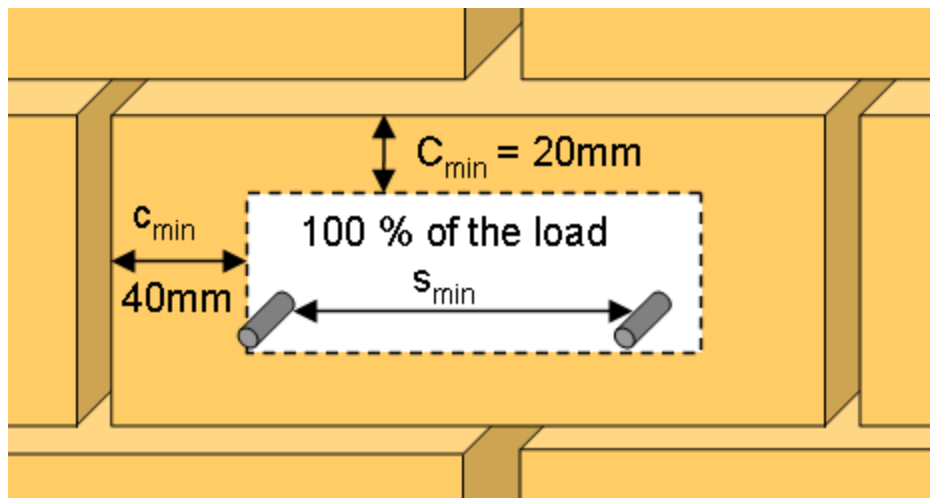

Edge distance and spacing influences

- The technical data for the HUS-HR anchors are reference loads for MZ 12 and KS 12, Due to the large variation of natural stone solid bricks, on site anchor testing is recommended to validate technical data,
- The HUS-HR anchor was installed and tested in center of solid bricks as shown, The HUS-HR anchor was not tested in the mortar joint between solid bricks or in hollow bricks; however a load reduction is expected,
- For brick walls where anchor position in brick can not be determined, 100% anchor testing is recommended,
- Distance to free edge free edge to solid masonry (Mz and KS) units ≥ 200 mm
- Distance to free edge free edge to solid masonry (autoclaved aerated gas concrete) units ≥ 170 mm
- The minimum distance to horizontal and vertical mortar joint (c_{min}) is stated in drawing above,
- Minimum anchor spacing (s_{min}) in one brick/block is $\geq 2 \cdot c_{min}$

Limits

- Applied load to individual bricks may not exceed 1,0 kN without compression or 1,4 kN with compression
- All data is for multiple use for non structural applications
- Plaster, graveling, lining or levelling courses are regarded as non-bearing and may not be taken into account for the calculation of embedment depth,