

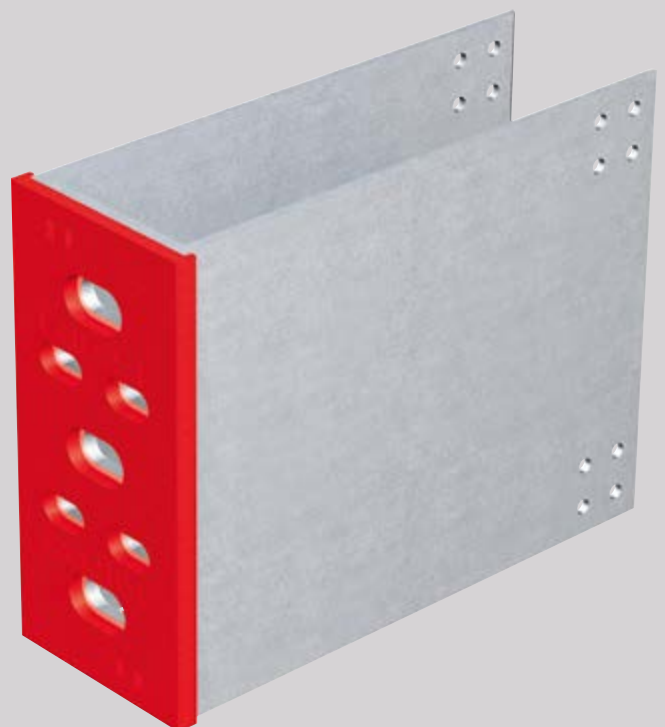

# MFT-S2S-2L- HANGERS- UNDERCUT ANCHORS

Hilti facade system



## CONTENT AND OVERVIEW

Panels	3
Application and Description	4
System Drawings	5-16
Brackets Range	
MFT-S2S Medium	17
MFT-S2S Large	17
Bracket Profile Adjustment	18
Products Range	19-20

MFT-S2S-2L-hangers-undercut anchors

-  Fiber-cement
-  HPL
-  Ceramic
-  Stone



This is an interactive page! Click on the move-back button to jump back to the CONTENT AND OVERVIEW.





## APPLICATION AND DESCRIPTION

### MFT-S2S-2L-hangers-undercut anchors

The system consists of aluminum wall brackets and profiles, and is specifically designed for vertical/horizontal substructures with undercut anchors for invisible fixing in ventilated facades. Wall brackets are supplied with pre-assembled isolators and with different hole geometries in the base plate (for installing anchors or screws). Support brackets are designed for bearing the loads coming from the ventilated facade (self and wind load). When needed, the flexible point brackets are used in order to fix the vertical profiles, holding up the wind loads and allowing the thermal expansion of the profile.

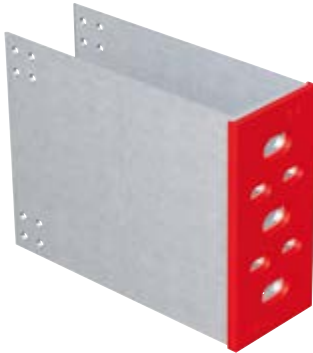

Vertical profiles are connected to the support brackets with specially designed screws for ventilated façade which avoids creating compressing forces from the profile against the wall brackets and keeps the profile connected by the support bracket in place. Additionally, each profile will be connected to each other through the connector which will be fixed to one of the box profiles in order to allow the second profile to expand.

Each bracket in combination with the profile will allow an adjustment in order to align the profile with the wall distance needed along the ventilated façade. With this system and depending on the profile we can have different tolerances in order to minimize the wall irregularities and install the cladding material as designed.

Wall brackets are available from 80 mm to 300 mm or without isolators from 75 mm to 295 mm, having available this items in steps of 20 mm. The isolator separates the substructure from the base material to reduce the thermal bridge and avoiding future corrosion problems.

The horizontal hanger profiles with elongated holes will be fixed on the vertical profiles. Fix points will be performed with 2 screws in the elongated holes; flexible points with 1 screw. Hangers are available in three different variants – fix-hangers; leveling-hangers and leveling-hangers with a fixation hole to the hanger profile.

#### Advantages:

- Only one support bracket per profile needed
- Profiles up to 4 m length fixed in only one support bracket
- Support bracket will be fixed only in the slab or the steel beam
- Different adjustment capability depending on the profile used
- Pre-assembled isolator
- The isolator separates the substructure from the base material reducing the thermal bridge
- Substructures can be designed with PROFIS facade generating technical and economically optimized solutions
- Can be used with all common cladding material
- Low installation time needed, saving labor costs

VIEW OF CLADDING

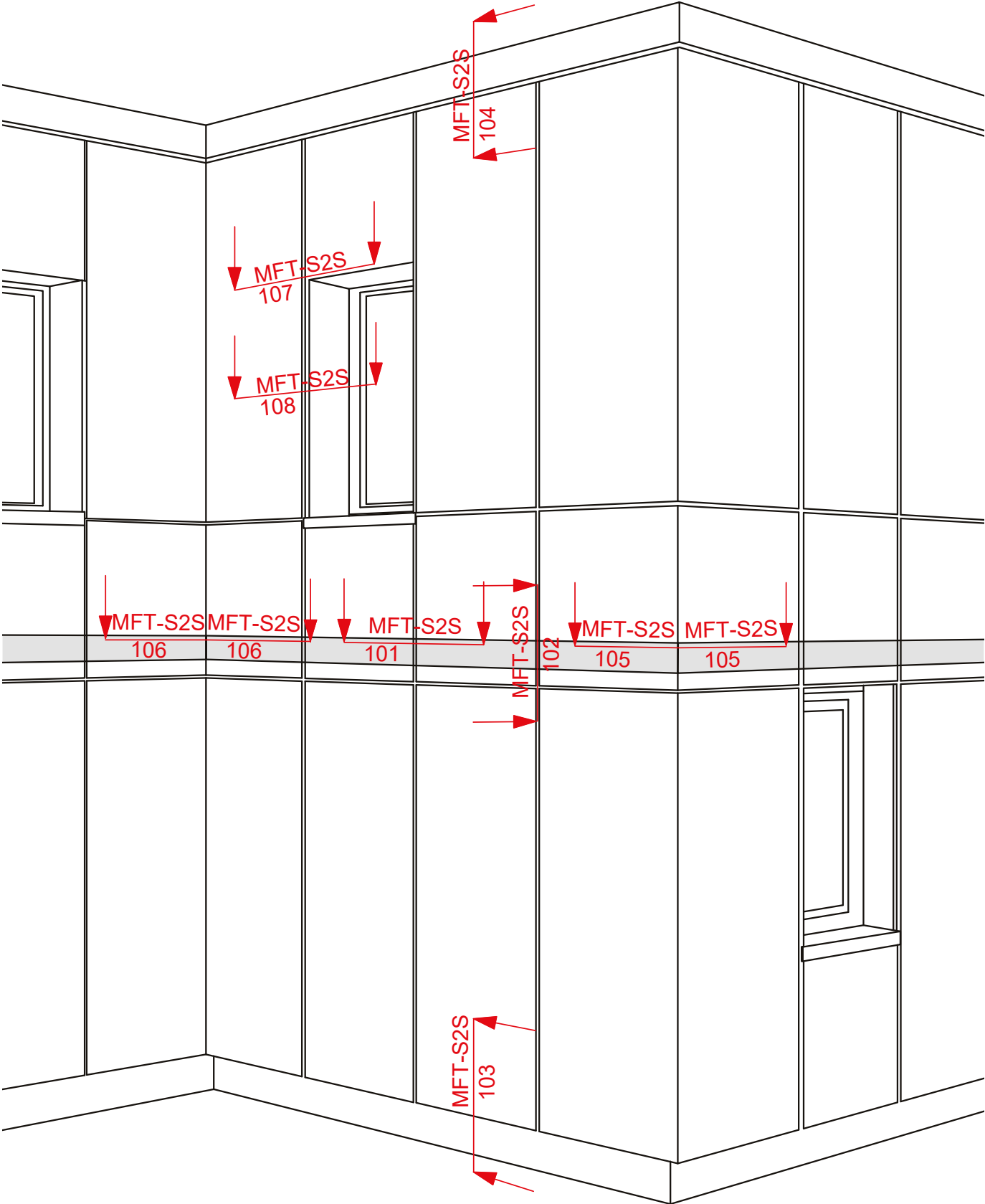

This is an interactive page! By clicking on a system part you get directed to the respective detail page. Click on the move-back button to jump back to the CONTENT AND OVERVIEW.



# MFT-S2S 101

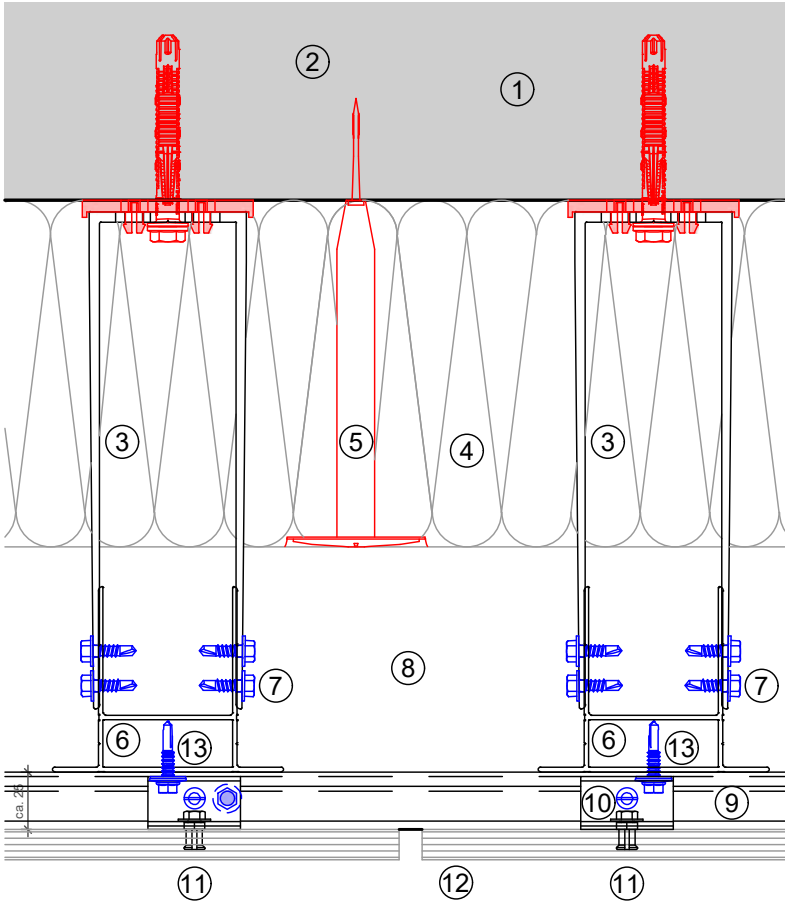

### Legend:

- ① Base material
- ② Anchor acc. to static
- ③ Bracket
- ④ Insulation
- ⑤ Insulation fastener
- ⑥ Profile
- ⑦ Self drilling screw
- ⑧ Ventilation gap
- ⑨ Load-bearing hanger profile
- ⑩ Hanger
- ⑪ Undercut anchor
- ⑫ Cladding
- ⑬ Profile fastener

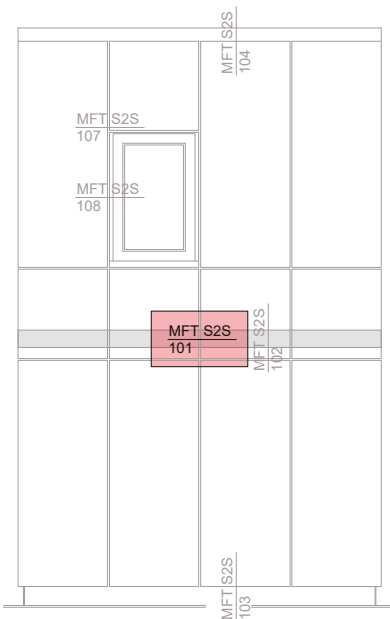

This is an interactive page! Click on the move-back button to jump back to the VIEW OF CLADDING.

MFT S2S 101

- A Make sure you have installed brackets in the right position and the reference profile.
- B Insert the connector in the reference TT profile.
- C Screw the TT PC with TT where the vertical mark is. See page 11.
- D Insert the 2nd profile into the TT PC.
- E Adjust it to the right position making sure you have free space to allow movement due to aluminium expansion.

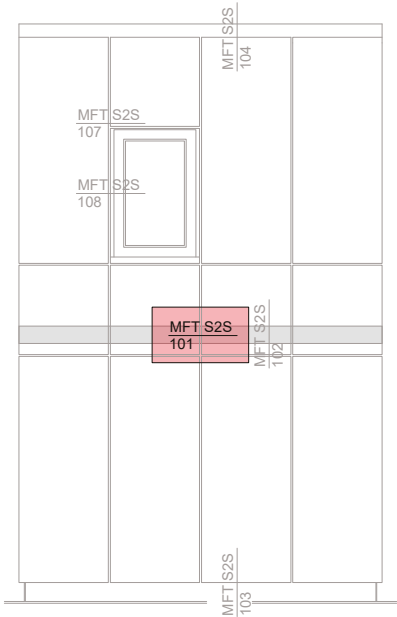
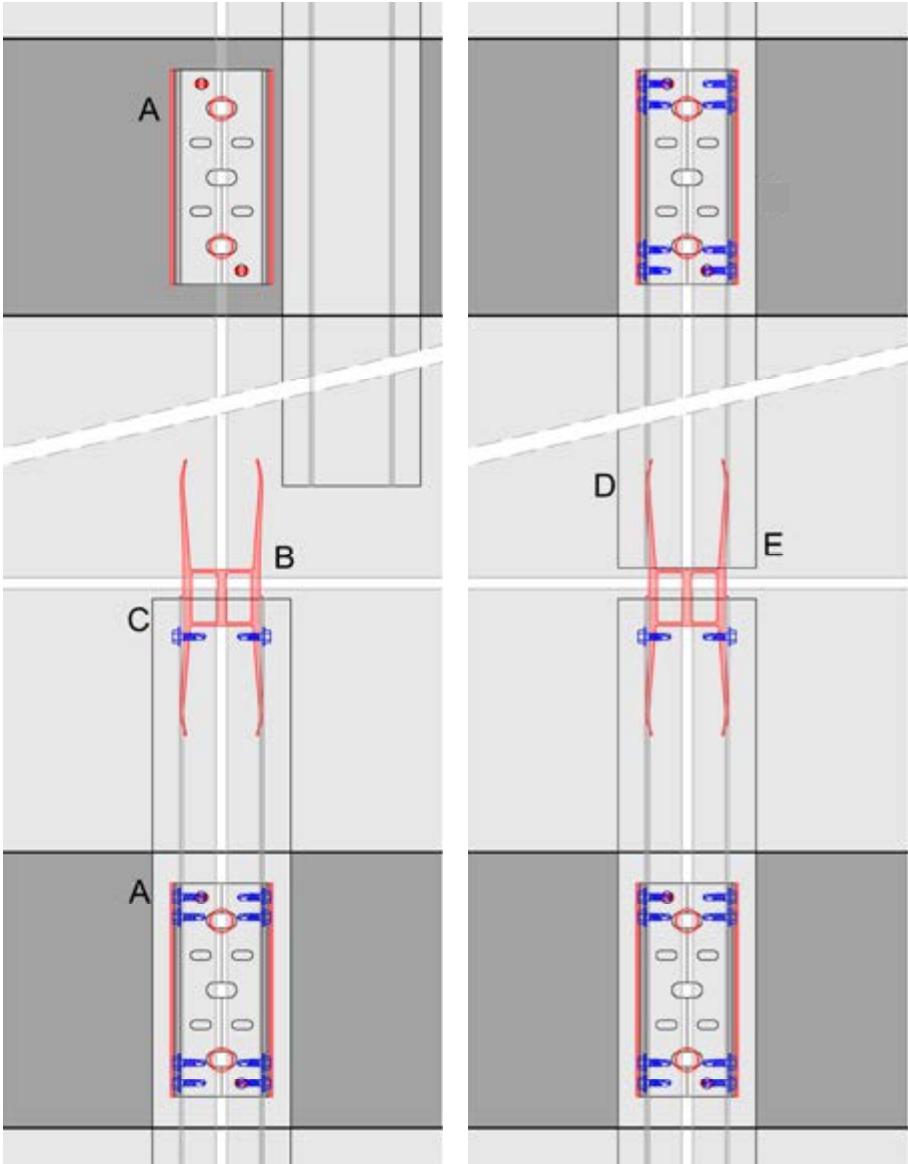

This is an interactive page! Click on the move-back button to jump back to the VIEW OF CLADDING.



# MFT-S2S 102

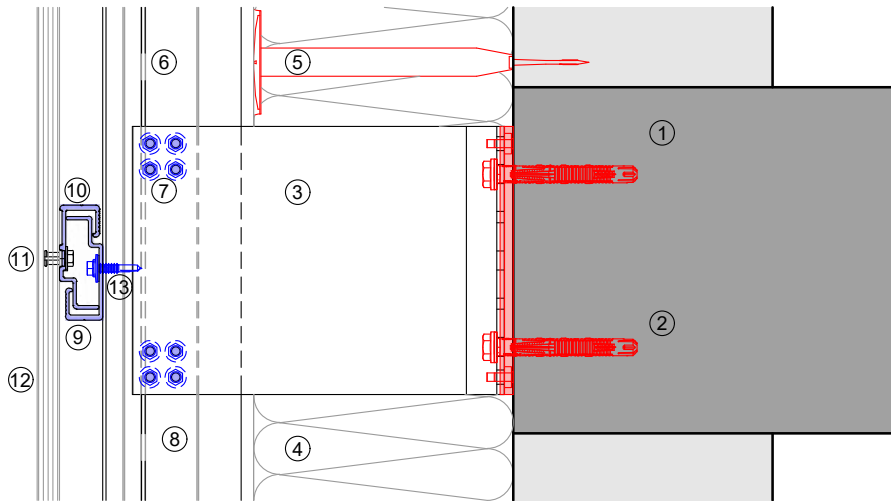

**Legend:**

- ① Base material
- ② Anchor acc. to static
- ③ Bracket
- ④ Insulation
- ⑤ Insulation fastener
- ⑥ Profile
- ⑦ Self drilling screw
- ⑧ Ventilation gap
- ⑨ Load-bearing hanger profile
- ⑩ Hanger
- ⑪ Undercut anchor
- ⑫ Cladding
- ⑬ Profile fastener

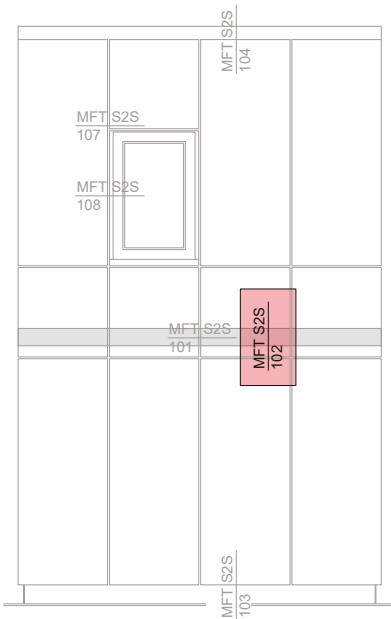

This is an interactive page! Click on the move-back button to jump back to the VIEW OF CLADDING.



MFT-S2S 103

**Legend:**

- ① Base material
- ② Anchor acc. to static
- ③ Bracket
- ④ Insulation
- ⑤ Insulation fastener
- ⑥ Profile
- ⑦ Self drilling screw
- ⑧ Ventilation gap
- ⑨ Load-bearing hanger profile
- ⑩ Hanger
- ⑪ Undercut anchor
- ⑫ Cladding
- ⑬ Profile fastener

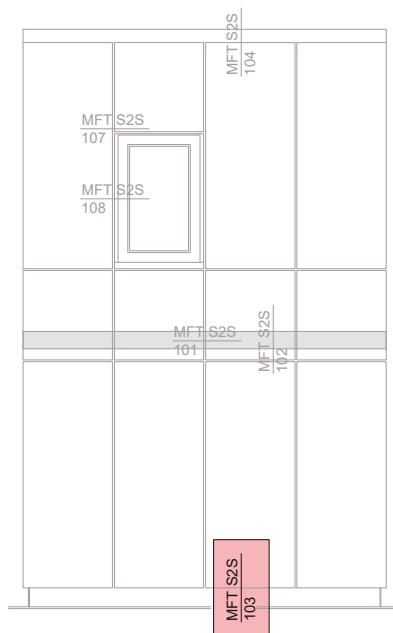
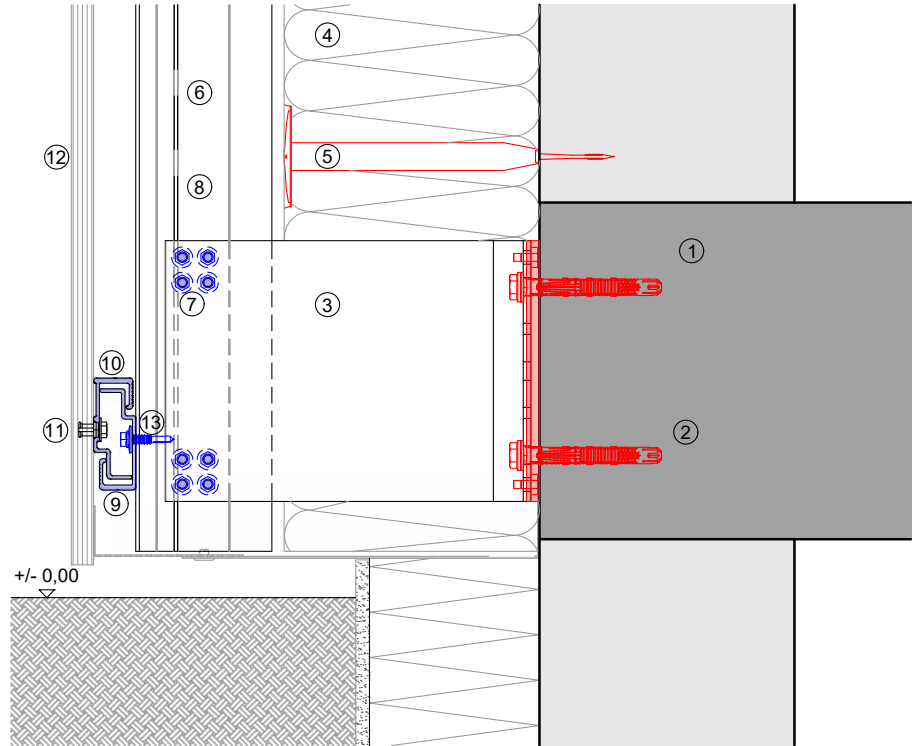

This is an interactive page! Click on the move-back button to jump back to the VIEW OF CLADDING.

MFT-S2S 104

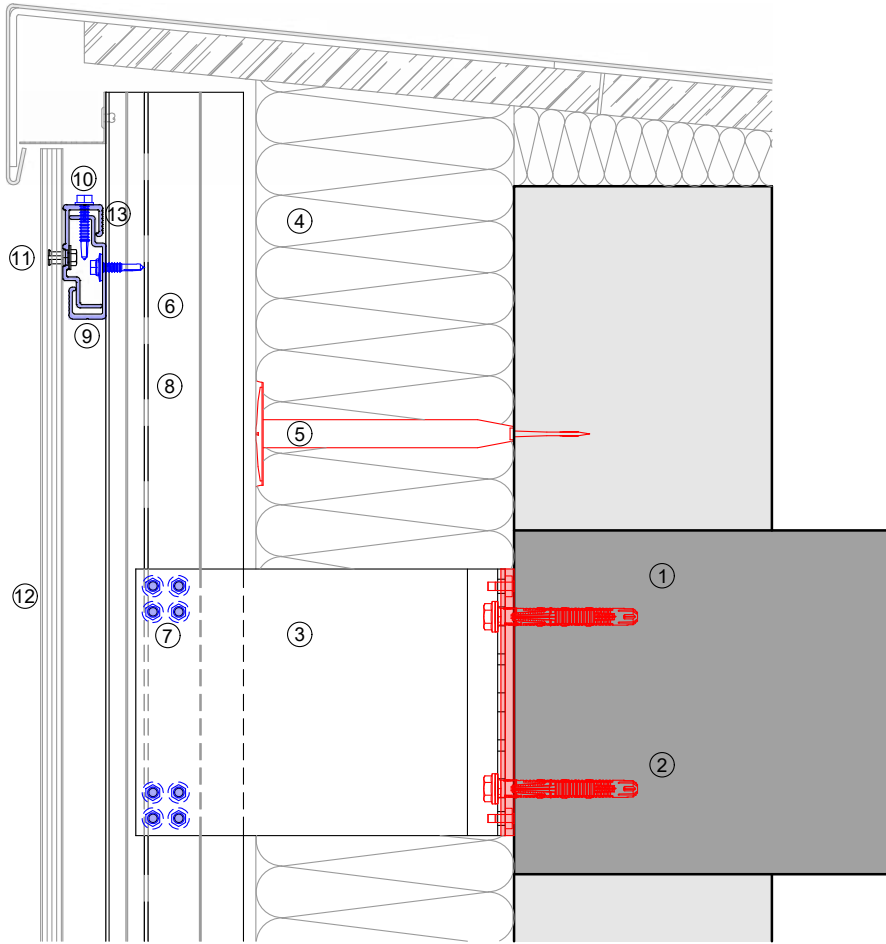

**Legend:**

- ① Base material
- ② Anchor acc. to static
- ③ Bracket
- ④ Insulation
- ⑤ Insulation fastener
- ⑥ Profile
- ⑦ Self drilling screw
- ⑧ Ventilation gap
- ⑨ Load-bearing hanger profile
- ⑩ Hanger
- ⑪ Undercut anchor
- ⑫ Cladding
- ⑬ Profile fastener

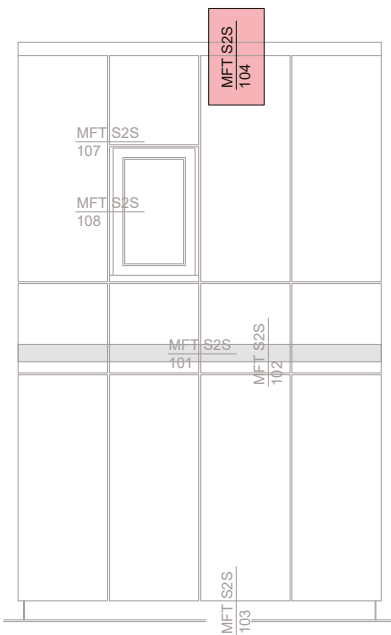

This is an interactive page! Click on the move-back button to jump back to the VIEW OF CLADDING.

MFT-S2S 105

Legend:

- ① Base material
- ② Anchor acc. to static
- ③ Bracket
- ④ Insulation
- ⑤ Insulation fastener
- ⑥ Profile
- ⑦ Self drilling screw
- ⑧ Ventilation gap
- ⑨ Load-bearing hanger profile
- ⑩ Hanger
- ⑪ Undercut anchor
- ⑫ Cladding
- ⑬ Profile fastener

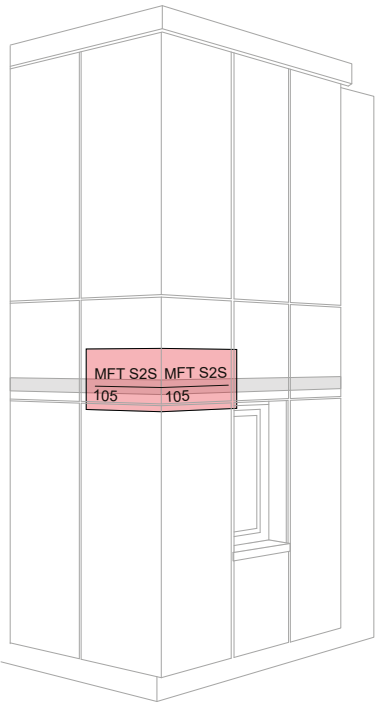
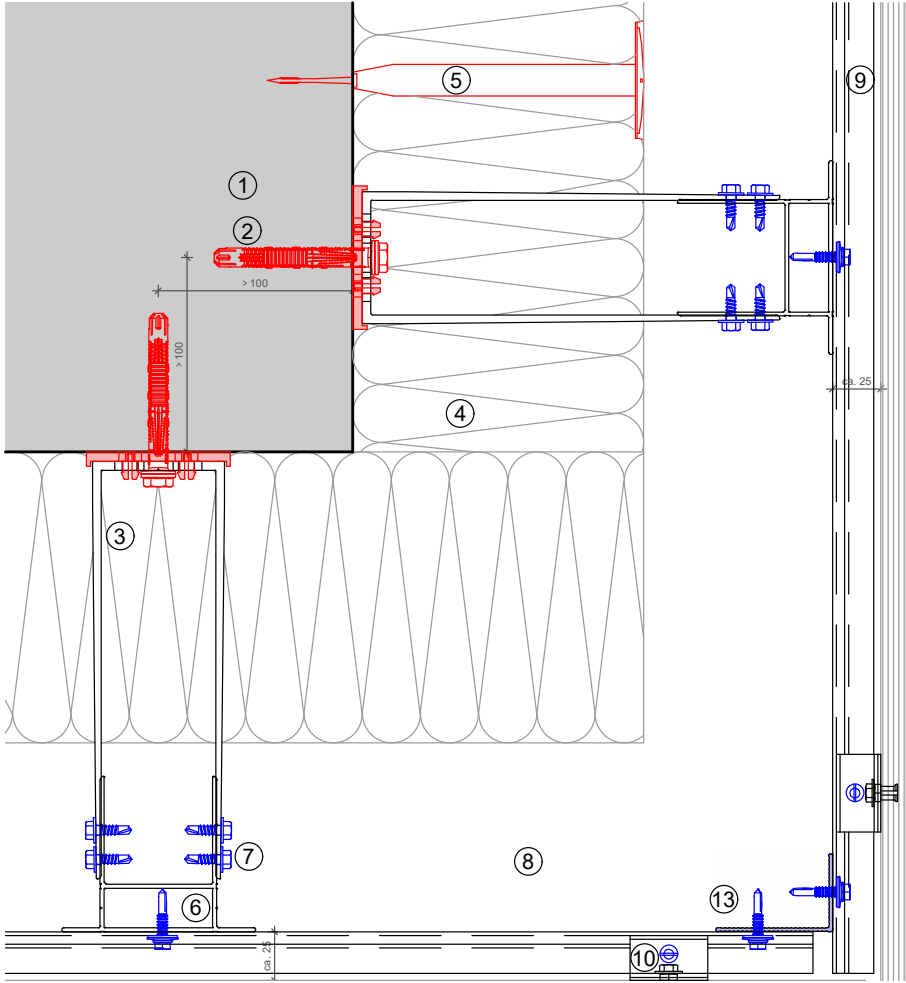

This is an interactive page! Click on the move-back button to jump back to the VIEW OF CLADDING.



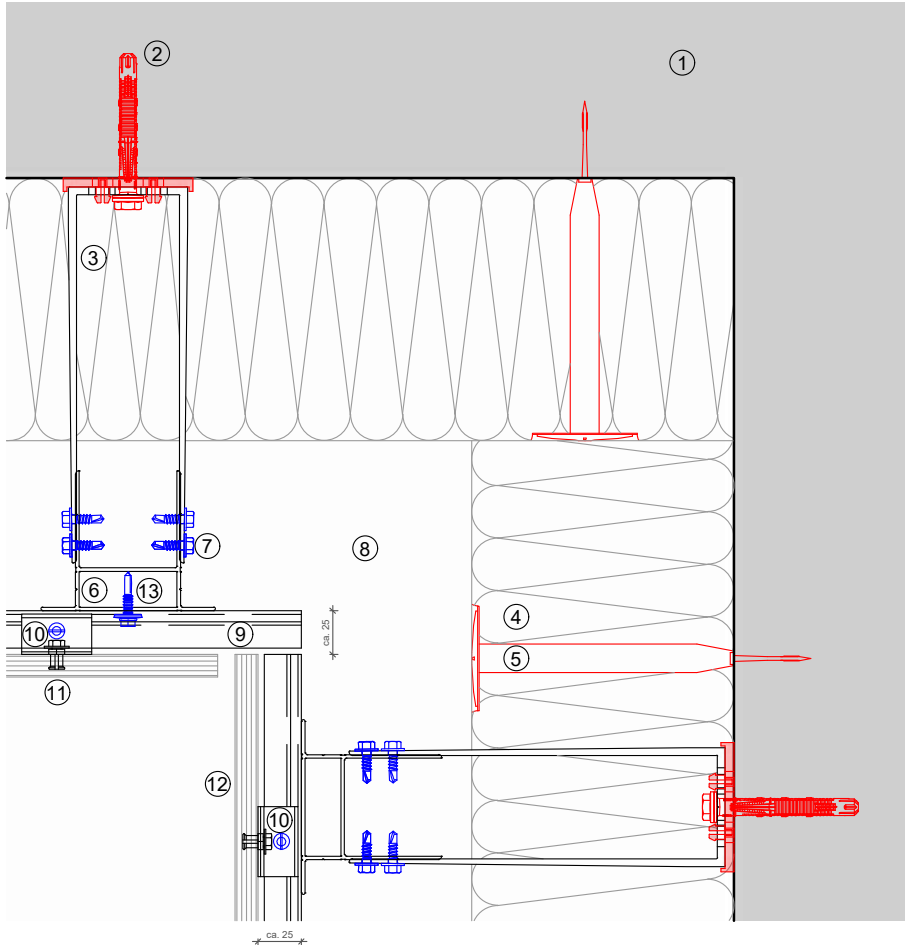

**Legend:**

- ① Base material
- ② Anchor acc. to static
- ③ Bracket
- ④ Insulation
- ⑤ Insulation fastener
- ⑥ Profile
- ⑦ Self drilling screw
- ⑧ Ventilation gap
- ⑨ Load-bearing hanger profile
- ⑩ Hanger
- ⑪ Undercut anchor
- ⑫ Cladding
- ⑬ Profile fastener

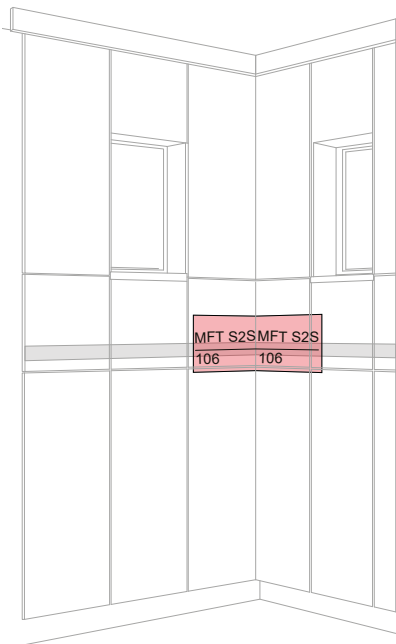

This is an interactive page! Click on the move-back button to jump back to the VIEW OF CLADDING.

MFT-S2S 107

Legend:

- ① Base material
- ② Anchor acc. to static
- ③ Bracket
- ④ Insulation
- ⑤ Insulation fastener- ⑥ Profile
- ⑦ Self drilling screw
- ⑧ Ventilation gap
- ⑨ Load-bearing hanger profile
- ⑩ Hanger
- ⑪ Undercut anchor
- ⑫ Cladding
- ⑬ Profile fastener
- ⑭ Window connector

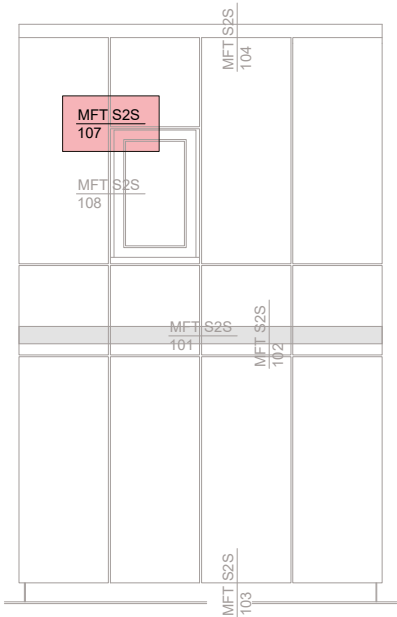
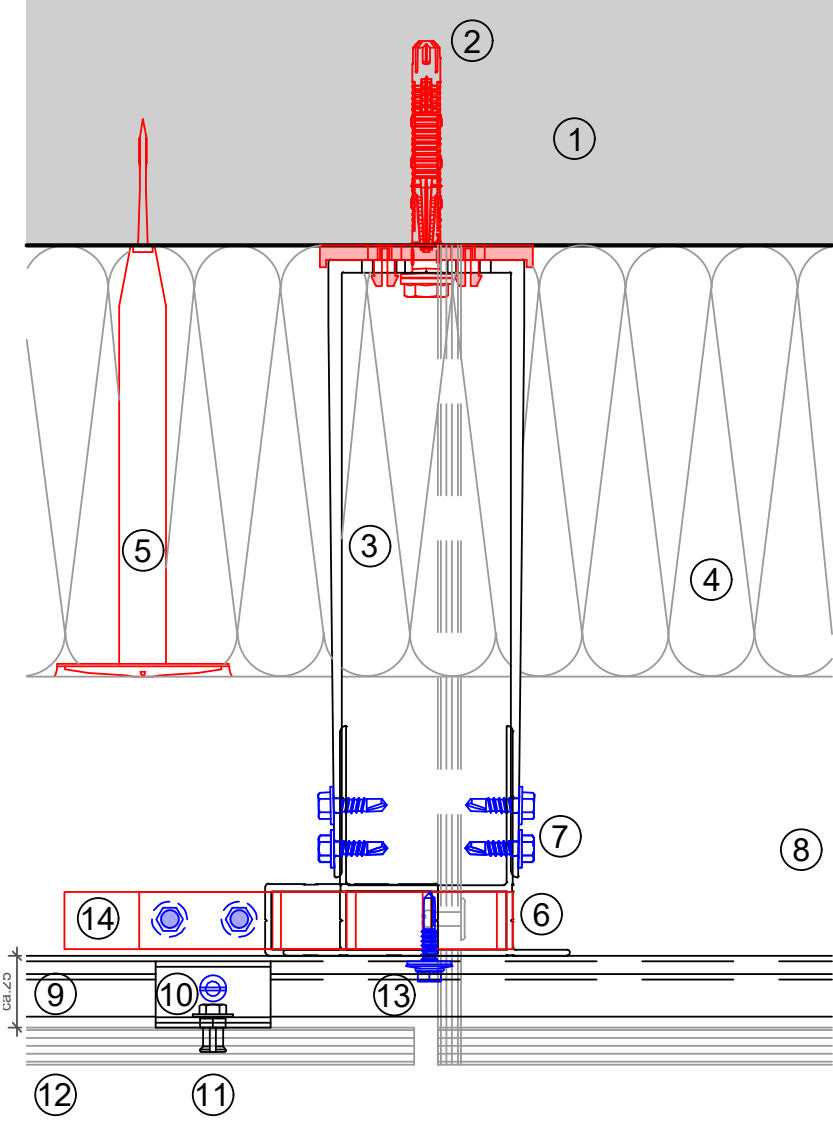

This is an interactive page! Click on the move-back button to jump back to the VIEW OF CLADDING.



MFT-S2S 108

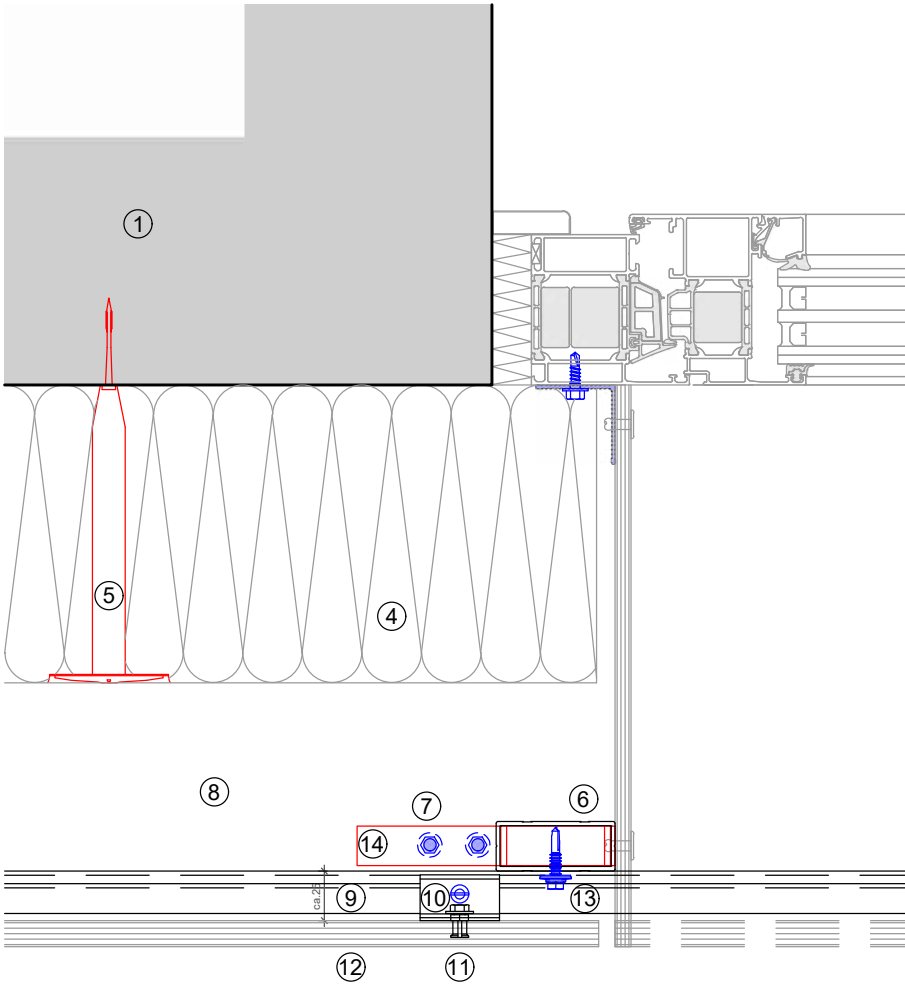

**Legend:**

- ① Base material
- ② Anchor acc. to static
- ③ Bracket
- ④ Insulation
- ⑤ Insulation fastener
- ⑥ Profile
- ⑦ Self drilling screw
- ⑧ Ventilation gap
- ⑨ Load-bearing hanger profile
- ⑩ Hanger
- ⑪ Undercut anchor
- ⑫ Cladding
- ⑬ Profile fastener
- ⑭ Window connector

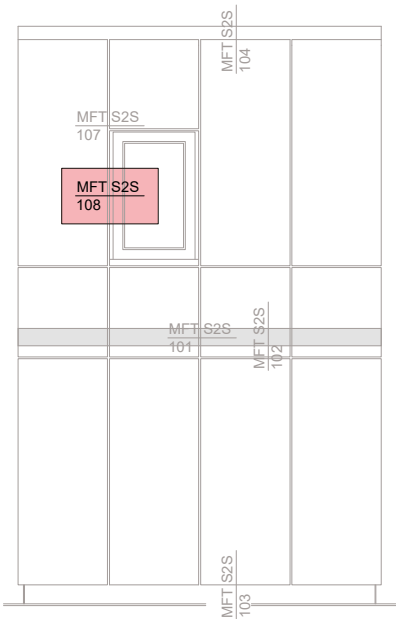

This is an interactive page! Click on the move-back button to jump back to the VIEW OF CLADDING.

## MFT S2S 108

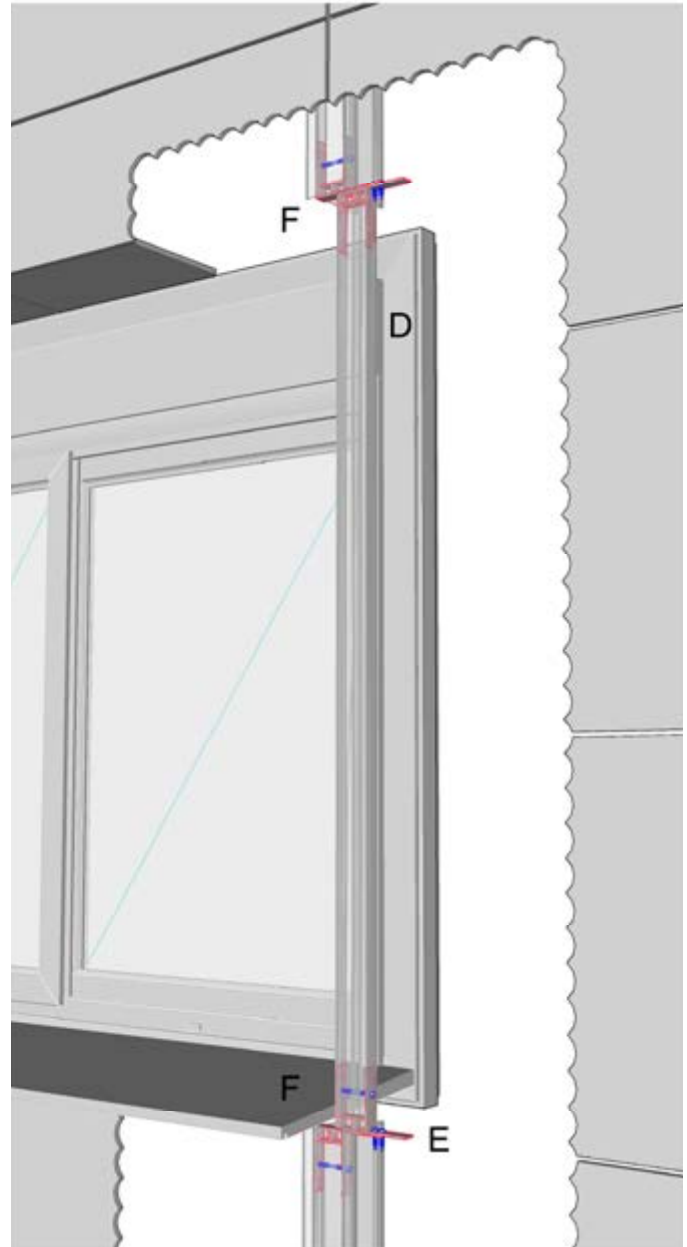
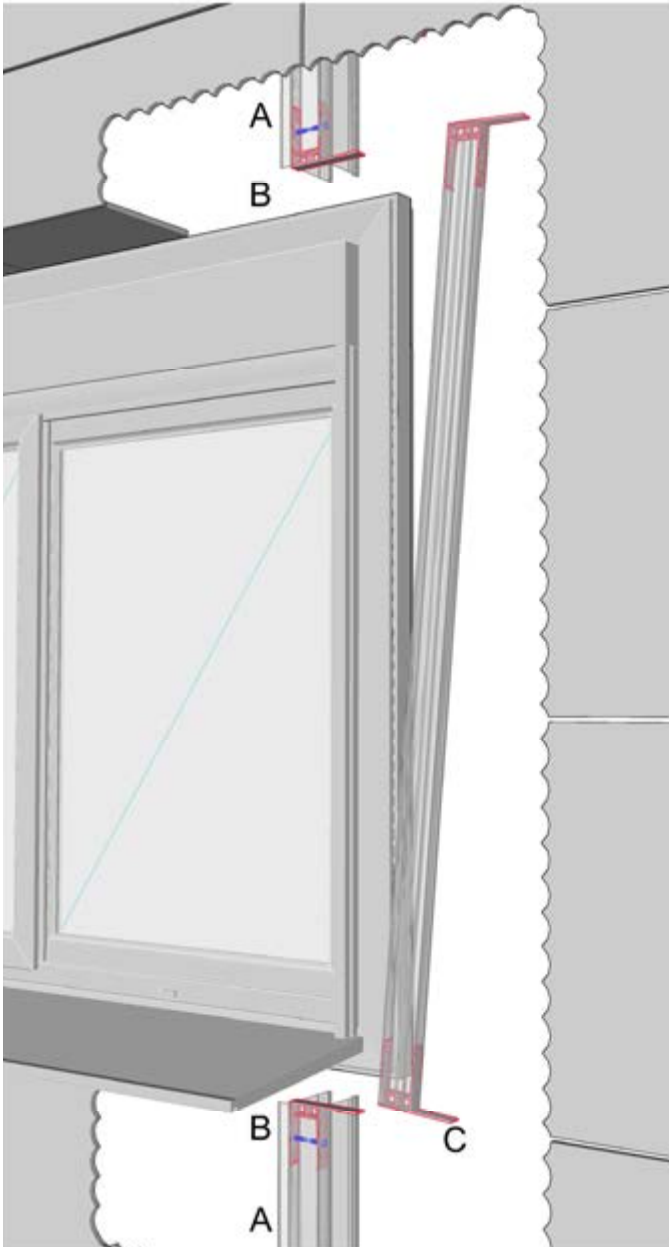

- A Make sure that the TT profile below and on top of the window are installed and aligned.
- B Insert RHS PC connector in the TT profiles and install the screws on the sides where the mark is.
- C Insert RHS PC in the RHS profile.
- D Bring the RHS with RHS PC to the right position for installing it on the side of the window.
- E Mount on top of the TT profile (below window profile), adjust the RHS PC in the right position and fix the screws in the flange.
- F Screw the spiders on the top RHS PC's flange making sure you have enough free space to allow the movement of the window profile (1,2mm per linear meter)

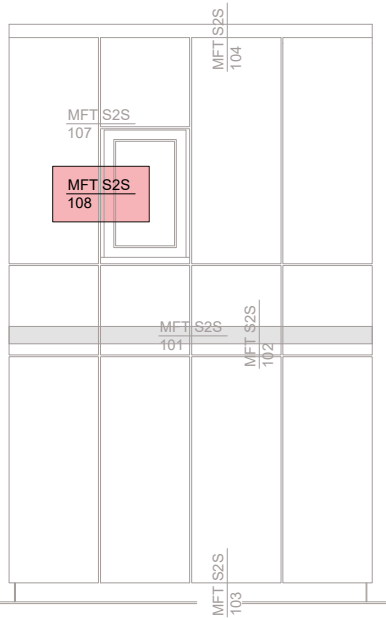
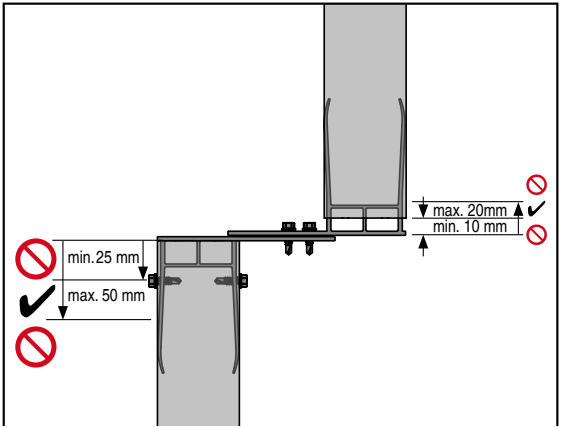
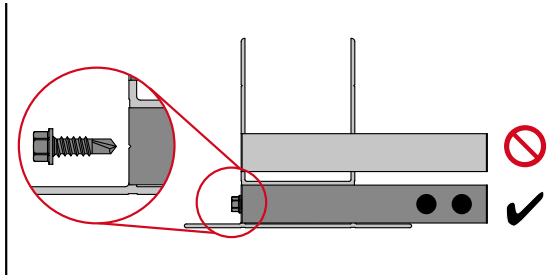
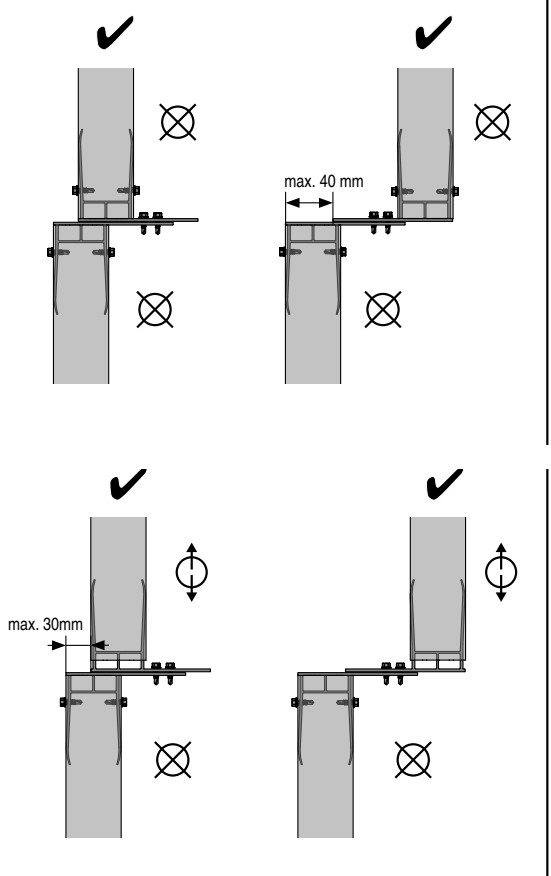
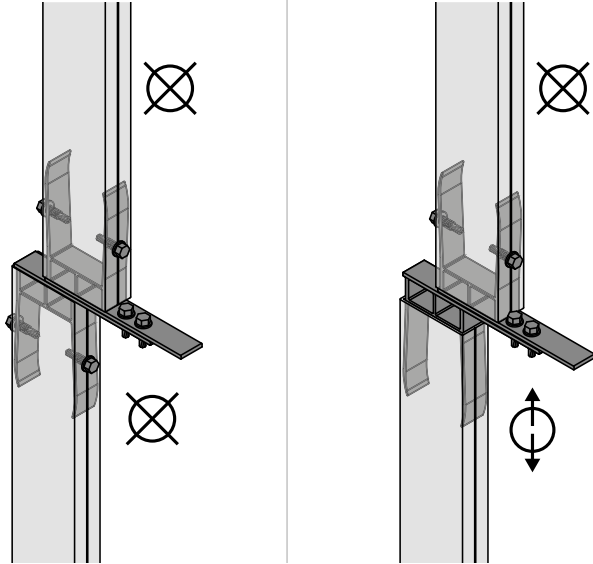



BRACKETS RANGE

MFT-S2S UI Medium

Order Description	Item No.	Length
MFT-S2S UI 080 M	2158286	80 mm
MFT-S2S UI 100 M	2158287	100 mm
MFT-S2S UI 120 M	2158288	120 mm
MFT-S2S UI 140 M	2158289	140 mm
MFT-S2S UI 160 M	2158410	160 mm
MFT-S2S UI 180 M	2158411	180 mm
MFT-S2S UI 200 M	2158412	200 mm
MFT-S2S UI 220 M	2158413	220 mm
MFT-S2S UI 240 M	2158414	240 mm
MFT-S2S UI 260 M	2158415	260 mm
MFT-S2S UI 280 M	2158416	280 mm
MFT-S2S UI 300 M	2158417	300 mm

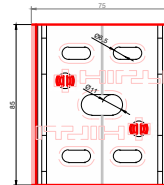
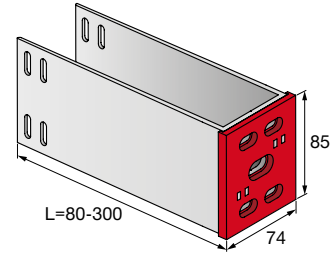

MFT-S2S UI Large

Order Description	Item No.	Length
MFT-S2S UI 080 L	2157966	80 mm
MFT-S2S UI 100 L	2157967	100 mm
MFT-S2S UI 120 L	2157968	120 mm
MFT-S2S UI 140 L	2157969	140 mm
MFT-S2S UI 160 L	2158380	160 mm
MFT-S2S UI 180 L	2158381	180 mm
MFT-S2S UI 200 L	2158382	200 mm
MFT-S2S UI 220 L	2158383	220 mm
MFT-S2S UI 240 L	2158384	240 mm
MFT-S2S UI 260 L	2158385	260 mm
MFT-S2S UI 280 L	2158386	280 mm
MFT-S2S UI 300 L	2158387	300 mm

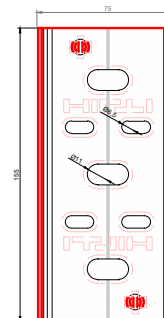
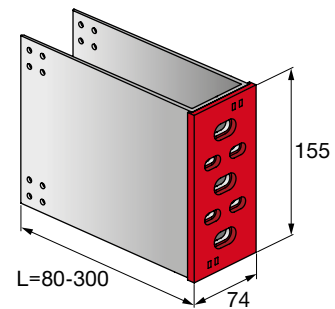

The length shown includes the isolator thickness.

## BRACKET PROFILE ADJUSTMENT

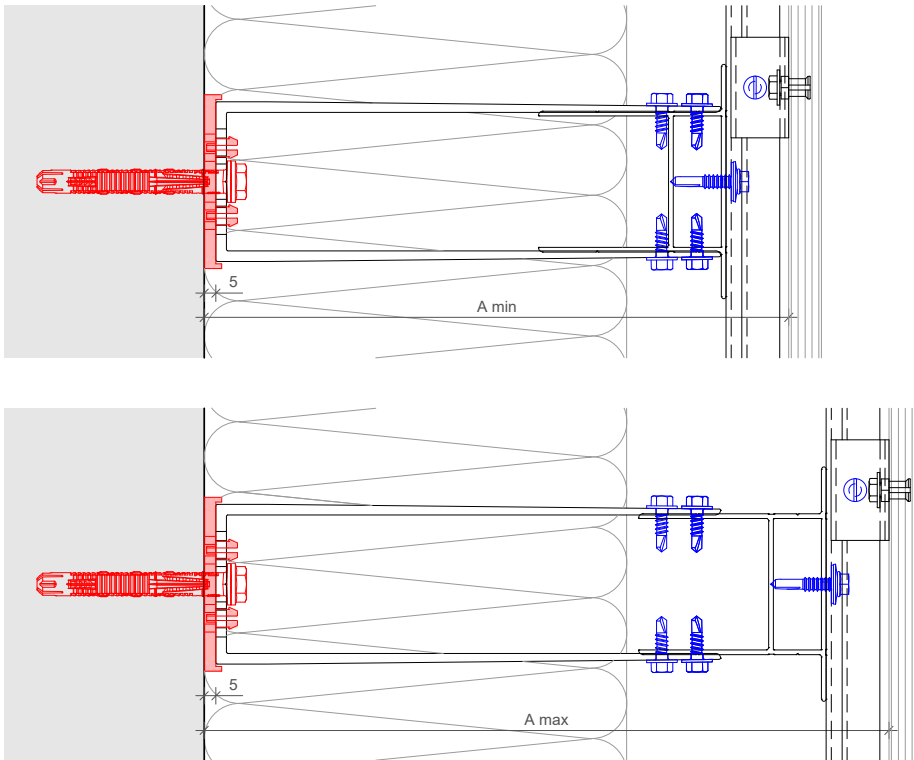

Profiles	MFT-S2S TT 80x120x2,0 6m 80x120x2,5 6m 80x100x2,0 6m 80x100x2,5 6m		MFT-S2S TT 100x120x2,0 6m 100x120x2,5 6m 100x100x2,0 6m 100x100x2,5 6m		MFT-S2S TT 110x120x2,0 6m 110x120x2,5 6m 110x100x2,0 6m 110x100x2,5 6m		MFT-S2S TT 135x120x2,0 6m 135x120x2,5 6m 135x100x2,0 6m 135x100x2,5 6m		MFT-S2S TT 150x120x2,0 6m 150x120x2,5 6m 150x100x2,0 6m 150x100x2,5 6m	
	A min*	A max*	A min*	A max*	A min*	A max*	A min*	A max*	A min*	A max*
MFT-S2S UI 080 M/L	89.5	125	109.5	145	119.5	150	144.5	170	159.5	180
MFT-S2S UI 100 M/L	102	145	109.5	165	119.5	170	144.5	190	159.5	200
MFT-S2S UI 120 M/L	122	165	122	185	122	190	144.5	210	159.5	220
MFT-S2S UI 140 M/L	142	185	142	205	142	210	144.5	230	159.5	240
MFT-S2S UI 160 M/L	162	205	162	225	162	230	162	250	162	260
MFT-S2S UI 180 M/L	182	225	182	245	182	250	182	270	182	280
MFT-S2S UI 200 M/L	202	245	202	265	202	270	202	290	202	300
MFT-S2S UI 220 M/L	222	265	222	285	222	290	222	310	222	320
MFT-S2S UI 240 M/L	242	285	242	305	242	310	242	330	242	340
MFT-S2S UI 260 M/L	262	305	262	325	262	330	262	350	262	360
MFT-S2S UI 280 M/L	282	325	282	345	282	350	282	370	282	380
MFT-S2S UI 300 M/L	302	345	302	365	302	370	302	390	302	400

\* The distance shown is valid for profile of 2,0 mm.



This is an interactive page! Click on the move-back button to jump back to the CONTENT AND OVERVIEW.

PRODUCTS RANGE

Bracket fastener



Brackets



## PRODUCTS RANGE

### Profiles

MFT-S2S TT

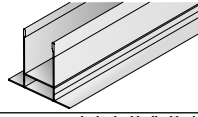

MFT-S2S RHS

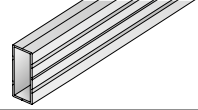

MFT-HP



### Profile fastener

S-AD



### Accessories

MFT-ISO

MFT-S2S UI AP L



MFT-S2S UI TT PC

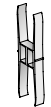

MFT-S2S UI RHS PC

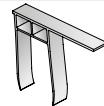

MFT-H



### Insulation fasteners

Insulation fasteners

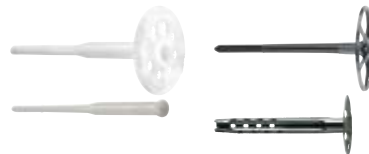





Hilti Corporation  
9494 Schaan Liechtenstein  
P +423-234 2111

[www.facebook.com/hiltigroup](https://www.facebook.com/hiltigroup)  
[www.hilti.group](http://www.hilti.group)